

JOURNAL OF

Public Transportation

-
- Herbert S. Levinson
Samuel Zimmerman
Jennifer Clinger
Scott C. Rutherford
- Bus Rapid Transit: An Overview
-
- James T. Jarzab
James Lightbody
Eugene Maeda
- Characteristics of Bus Rapid Transit Projects:
An Overview
-
- Steven E. Polzin
Michael R. Baltes
- Bus Rapid Transit: A Viable Alternative?
-
- Vukan R. Vuchic
- Bus Semirapid Transit
Mode Development and Evaluation
-
- Graham N. Carey
- Applicability of BRT to Corridors
-
- Peter Koonce
John Ringert
Tom Urbanik
- Willie Rotich
Bill Kloos
- Detection Range Setting Methodology
for Signal Priority
-
- Matthew Pahs
Mark Rohden
David Hampsten
- Seth Gallant
Robert L. Bertini
- Door-to-Door Mobility:
Evaluating a BRT Community Transport Concept
-
- Sean Rathwell
Stephen Schijns
- Ottawa and Brisbane:
Comparing a Mature Busway System

Gary L. Brosch, *Editor*
Laurel A. Land, AICP, *Managing Editor*

EDITORIAL BOARD

Robert B. Cervero, Ph.D.
University of California, Berkeley

William W. Millar
American Public Transit Association

Chester E. Colby
E & J Consulting

Steven E. Polzin, Ph.D., P.E.
University of South Florida

Gordon Fielding, Ph.D.
University of California, Irvine

Sandra Rosenbloom, Ph.D.
University of Arizona

David J. Forkenbrock, Ph.D.
University of Iowa

Lawrence Schulman
LS Associates

Jose A. Gomez-Ibanez, Ph.D.
Harvard University

George Smerk, D.B.A.
Indiana University

Naomi W. Lede, Ph.D.
Texas Transportation Institute

The contents of this document reflect the views of the authors, who are responsible for the facts and the accuracy of the information presented herein. This document is disseminated under the sponsorship of the U.S. Department of Transportation, University Research Institute Program, in the interest of information exchange. The U.S. Government assumes no liability for the contents or use thereof.

SUBSCRIPTIONS

Complimentary subscriptions can be obtained by contacting:

Laurel A. Land, *Managing Editor*
Center for Urban Transportation Research (CUTR) • University of South Florida
4202 East Fowler Avenue, CUT 100 • Tampa, FL 33620-5375
Phone: 813•974•9759
Fax: 813•974•5168
Email: land@cutr.usf.edu
Web: www.nctr.usf.edu/journal

SUBMISSION OF MANUSCRIPTS

The *Journal of Public Transportation* is a quarterly, international journal containing original research and case studies associated with various forms of public transportation and related transportation and policy issues. Topics are approached from a variety of academic disciplines, including economics, engineering, planning, and others, and include policy, methodological, technological, and financial aspects. Emphasis is placed on the identification of innovative solutions to transportation problems.

All articles should be approximately 4,000 words in length (18-20 double-spaced pages). Manuscripts not submitted according to the journal's style will be returned. Submission of the manuscript implies commitment to publish in the journal. Papers previously published or under review by other journals are unacceptable. All articles are subject to peer review. Factors considered in review include validity and significance of information, substantive contribution to the field of public transportation, and clarity and quality of presentation. Copyright is retained by the publisher, and, upon acceptance, contributions will be subject to editorial amendment. Authors will be provided with proofs for approval prior to publication.

All manuscripts should be typed double-spaced on 8.5" x 11" paper. Footnotes, abstract, and references should also be double-spaced. Upon acceptance, the final manuscript should be accompanied by an electronic copy in a Word or ASCII file. Manuscripts should consist of type and equations only. All tables, illustrations, footnotes, and photographs should be grouped at the end of the text, and all pages should be numbered. All manuscripts should include sections in the following order, as specified: *Cover Page*—title, subtitle, and short biographical sketch of author and co-authors; *First Page* of manuscript—title, abstract (up to 150 words); *Main Body*—organized under section headings; *References*—*Chicago Manual of Style*, author-date format. All graphs, drawings, and diagrams (referred to as Figures), as well as tables (referred to as Tables) should be numbered consecutively in Arabic numerals with their position indicated in the text. Each table must have a title and each illustration must have a caption. Each drawing, diagram, picture, and/or photograph should be submitted as a separate document in JPG or TIF electronic format with an accompanying caption.

Submit manuscripts to the Managing Editor, as indicated above.

Public Transportation

Volume 5, No. 2, 2002
ISSN 1077-291X

In cooperation with the
National Bus Rapid Transit Institute
www.nbrti.org



The *Journal of Public Transportation* is published quarterly by
National Center for Transit Research
Center for Urban Transportation Research
University of South Florida • College of Engineering
4202 East Fowler Avenue, CUT100
Tampa, Florida 33620-5375
Phone: 813•974•3120
Fax: 813•974•5168
Email: land@cutr.usf.edu
Website: www.nctr.usf.edu/journal

© 2002 Center for Urban Transportation Research

Public Transportation

JOURNAL OF

Volume 5, No. 2, 2002
ISSN 1077-291X

CONTENTS

Preface	iv
Editorial	v
Bus Rapid Transit: An Overview <i>Herbert S. Levinson, Samuel Zimmerman, Jennifer Clinger, and Scott C. Rutherford</i>	1
Characteristics of Bus Rapid Transit Projects: An Overview <i>James T. Jarzab, James Lightbody, and Eugene Maeda</i>	31
Bus Rapid Transit: A Viable Alternative? <i>Steven E. Polzin and Michael R. Baltus</i>	47
Bus Semirapid Transit Mode Development and Evaluation <i>Vukan R. Vuchic</i>	71
Applicability of Bus Rapid Transit to Corridors with Intermediate Levels of Transit Demand <i>Graham N. Carey</i>	97
Detection Range Setting Methodology for Signal Priority <i>Peter Koonce, John Ringert, Tom Urbanik, Willie Rotich, and Bill Kloos</i>	115
Door-to-Door Mobility: Evaluating a Bus Rapid Transit Community Transport Concept <i>Matthew Pahs, Mark Rohden, David Hampsten, Seth Gallant, and Robert L. Bertini</i>	137
Ottawa and Brisbane: Comparing a Mature Busway System with Its State-of-the-Art Progeny <i>Sean Rathwell and Stephen Schijns</i>	163

PREFACE

Welcome to this special Bus Rapid Transit (BRT) edition of the *Journal of Public Transportation*. This edition is the Journal's attempt to present information related to the emerging concept of Bus Rapid Transit and to assist the reader in determining its parameters, uniqueness, validity, and significance.

There is no question that there is a dramatic increase in interest in the BRT concept. In the United States, as part of a BRT Consortium with the Federal Transit Administration (FTA), at least 17 cities are planning to incorporate aspects of Bus Rapid Transit into their transportation networks. In addition, upwards of 40 to 50 communities in the United States are currently considering BRT in their transportation planning efforts. Advocates believe Bus Rapid Transit promises to improve travel time, service reliability and customer convenience, foster livable communities, and introduce cost-effective, environmentally-friendly technologies.

The National Bus Rapid Transit Institute (NBRTI) has been established as a partnership of the University of South Florida and University of California at Berkeley, in cooperation with the FTA. The mission of the NBRTI is to facilitate the sharing of knowledge and innovation for increasing the speed, efficiency, and reliability of high-capacity bus service through the implementation of BRT systems.

This edition of the *Journal of Public Transportation* covers a variety of topics related to Bus Rapid Transit, including three articles giving us a broad perspective of BRT by providing an overview, alternative characteristics, and BRT as a viable transportation alternative. In addition, articles are presented which examine the applicability of BRT in corridors with intermediate levels of transit demand, a methodology for setting a detection range for BRT signal priority, and an evaluation of BRT as a community alternative for door-to-door mobility.

While BRT is a rapidly-growing national trend in the provision of public transportation service, there is still a long way to go in understanding the appropriate role for BRT in our transportation systems toolbox. It is hoped that this special edition of the *Journal* will increase communication between academics and practitioners in public transportation, aiming toward the common goal of improving the mobility of our citizens.

Special recognition and appreciation go to our special editors for this issue, Messrs. Bert Arrillaga and Edward Thomas.

Gary L. Brosch, Editor
Journal of Public Transportation

EDITORIAL

I would like to thank CUTR and especially the editor of the *Journal of Public Transportation* for dedicating a special edition to the subject of Bus Rapid Transit (BRT). The breadth of papers that were submitted for this special edition is an indication of the interest that has surfaced in BRT during the last few years.

The Federal Transit Administration started the BRT program officially in 1999 by selecting sites that would be national demonstrations of BRT. The program has been involved with a variety of activities designed to provide information to the transit industry about the benefits and drawbacks of BRT. Projects implemented throughout the United States will be part of a formal data collection and evaluation effort designed to document operational impacts on ridership, travel times, costs, service effectiveness, and customer perception and acceptance. Numerous workshops have been conducted to share information on marketing, operations, and technology applicable to BRT. Scanning tours have been held at BRT operations in Brazil and Europe, giving an opportunity for transit leaders to study successful implementations abroad. Research studies have also been supported to provide specific information regarding the characteristics of BRT and the type of vehicle most appropriate for BRT service. A computer simulator is under development to help cities analyze alternative BRT scenarios, and develop visual representation of their operations. The National Bus Rapid Transit Institute that has been funded at the University of South Florida will also expand on BRT activities, serving as a clearinghouse of information and contributing in other areas such as marketing, evaluations, and technology sharing.

BRT promises to be able to provide a high level of service at a reasonable cost. It is an emerging subject that requires research and information in a number of areas. I hope that this special edition of the *Journal* and the contribution of the authors is a beginning, and that it will challenge its readers to make contributions in this area of mass transportation.

Bert Arrillaga, Chief
Service Innovation Division
Federal Transit Administration

Bus Rapid Transit: An Overview

*Herbert S. Levinson, Transportation Consultant
Samuel Zimmerman and Jennifer Clinger, DMJM+Harris
C. Scott Rutherford, University of Washington*

Abstract

Bus Rapid Transit (BRT) is growing in popularity throughout the world. The reasons for this phenomenon include its passenger and developer attractiveness, its high performance and quality, and its ability to be built quickly, incrementally, and economically. BRT also provides sufficient transport capacity to meet demands in many corridors, even in the largest metropolitan regions. In the United States, the development of BRT projects has been spurred by the Federal Transit Administration's (FTA) BRT initiative. These projects have been undertaken, in part, because of the imbalance between the demand for "New Starts" funds and available resources.

Decisions to make BRT investments should be the result of a planning process that stresses problem solving, addressing needs, and the objective examination of a full range of potential solutions, of which BRT is only one. Good planning practice means matching potential market characteristics with available rights-of-way. BRT involves an integrated system of facilities, services, amenities, operations, and Intelligent Transportation Systems (ITS) improvements that are designed to improve performance, attractiveness to passengers, image, and identity. Because they can be steered as well as guided, BRT vehicles can operate in a wide range of environments without forcing transfers or requiring expensive running way construction over the entire range of their operation. Through this flexibility, BRT can provide one-seat, high-quality transit performance over a geographic range beyond that of dedicated guideways. To the

maximum extent practical, the system should transfer the service attributes of rail transit to BRT.

Even where implementation of a comprehensive, integrated BRT system is not possible, many of its components can be adapted for use in conventional bus systems with attendant benefits in speed, reliability, and transit image/attractiveness.

In summary, BRT is growing in popularity because it can be cost-effective and it works. This article describes BRT concepts and components, traces BRT's evolution, gives its current status, and outlines some of the findings to date of the Transportation Research Board's (TRB) Transit Cooperative Research Program (TCRP) A-23 project, "Implementation Guidelines for Bus Rapid Transit."

Introduction: What Is BRT?

The FTA defines BRT as a "rapid mode of transportation that can combine the quality of rail transit and the flexibility of buses" (Thomas 2001).

A more detailed definition, which was developed as part of the TCRP A-23 project, is:

BRT is a flexible, rubber-tired rapid transit mode that combines stations, vehicles, services, running way, and ITS elements into an integrated system with a strong positive image and identity. BRT applications are designed to be appropriate to the market they serve and their physical surroundings and can be incrementally implemented in a variety of environments.

In brief, BRT is a permanently integrated system of facilities, services, and amenities that collectively improve the speed, reliability, and identity of bus transit. In many respects, BRT is rubber-tired light rail transit (LRT), but with greater operating flexibility and potentially lower capital and operating costs.

While BRT is often compared to LRT, other comparisons with rail modes may be more appropriate:

- Where BRT vehicles (buses) operate totally on exclusive or protected rights-of-way, the level of service provided can be similar to that of full Metrorail rapid transit.

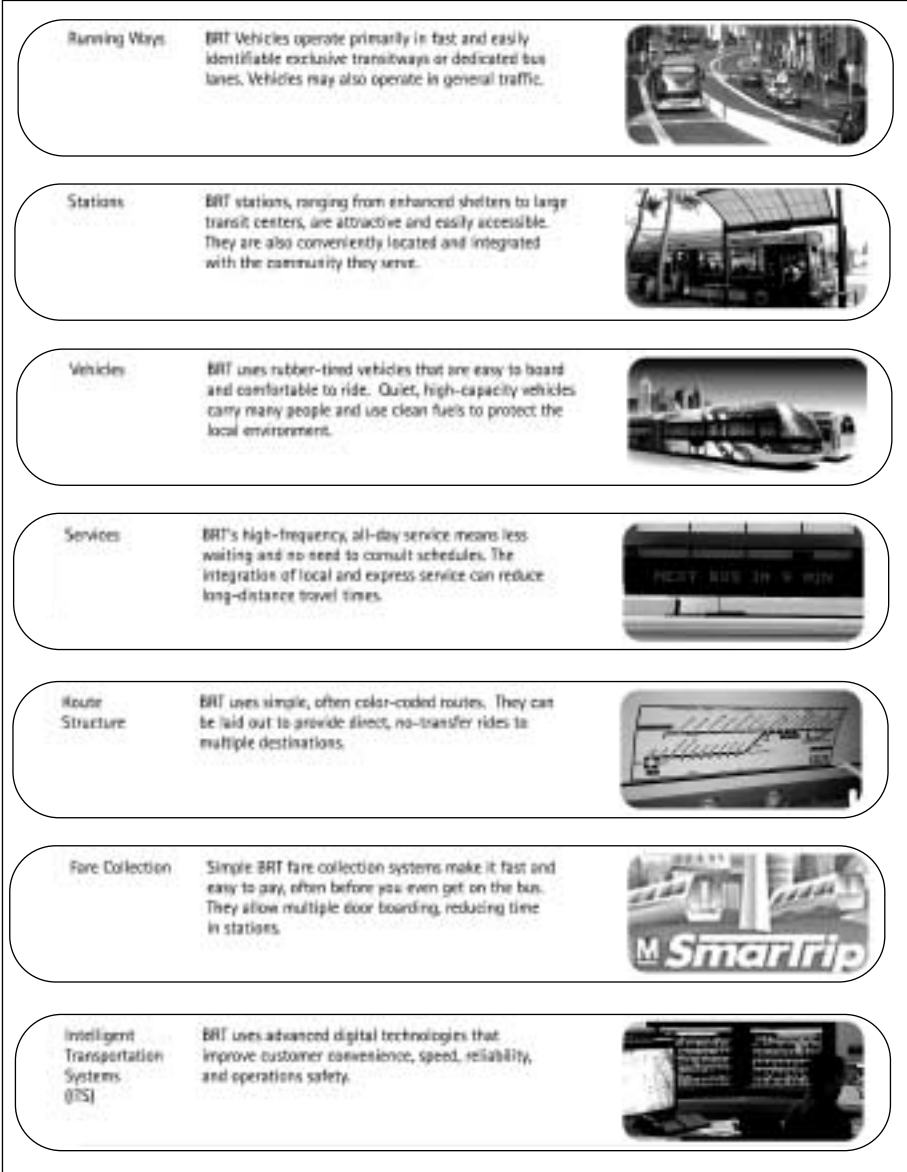

Figure 1. Components of Bus Rapid Transit

- Where buses operate in combinations of exclusive rights-of-way, median reservations, bus lanes, and street running, the level of service provided is very similar to LRT.
- Where buses operate mainly on city streets in mixed traffic, the level of service provided is similar to a limited-stop tram/streetcar system.

There are seven major components of BRT which relate to the key quality transit attributes of speed, reliability, and identity. Figure 1 describes these components in detail. Collectively, they form a complete rapid transit system that can improve customer convenience and reduce delays compared to local bus and street/trolley car systems (BRT Bus Rapid Transit 2001).

Why BRT?

There are many reasons for developing BRT systems, especially in a U.S. context.

1. Central business districts (CBDs) have continued to prosper and grow in ways that require more transport capacity and improved access, even though employment in U.S. CBDs is declining as a percentage of overall regional activity. Given the cost and environmental impacts associated with parking and road construction and the traditional urban form of most CBDs, improved and expanded public transport emerges as an important alternative for providing that capacity. In addition, many suburban-edge cities exceed the aggregate employment base of many big-city CBDs but do not currently have the focus and density to make rail-based rapid transit a cost-effective investment.
2. BRT systems can often be implemented quickly and incrementally.
3. For a given distance of dedicated running way, BRT is generally less costly to build than rail transit. Moreover, where BRT vehicles can reliably operate at high speeds on high-occupancy vehicle (HOV) lanes or general-purpose highways and streets over significant proportions of a given route, running way capital costs will be even lower compared to those for rail modes, which must be purpose-built over the entire distance covered.

4. BRT can be the most cost-effective means of serving a broad variety of urban and suburban environments. BRT vehicles—whether they are driver-steered or electronically guided—can operate on streets, in freeway medians, on railroad rights-of-way, on aerial structures, and underground. BRT systems can also provide a broad array of express, limited-stop, and local all-stop services on a single facility without complex signal and guideway switching systems.
5. BRT can provide quality performance with sufficient transport capacity for most corridors in U.S. and Canadian cities. For example, the Ottawa transitway system’s link to the CBD carries more people in the peak hour than most LRT segments in North America. The Brisbane South East Busway carries approximately the same number of maximum load point, peak-hour, peak-direction passengers—about 10,000 per hour. Many BRT lines in South American cities carry peak-hour passenger flows that equal or exceed those on many U.S. and Canadian fully grade-separated rail rapid transit lines. For example, Bogota’s TransMillenio system serves more than 25,000 peak-hour, peak-direction maximum load point riders.

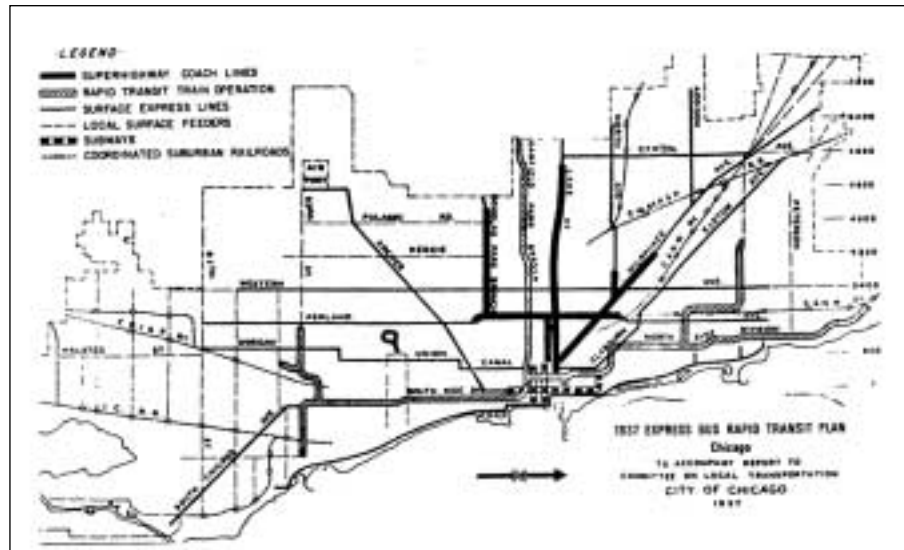

Figure 2. 1937 Express Bus Rapid Transit Plan—Chicago

6. BRT is well suited to extend the reach of rail transit lines providing feeder services to/from areas where densities are too low to cost effectively extend the rail corridor. Examples of this application are the South Dade Busway in South Miami-Dade County and the Pie IX Busway in Montreal.
7. BRT can be integrated into urban environments in ways that foster economic development and transit- and pedestrian-friendly design. For example, in Boston, Ottawa, and Brisbane, BRT has been part of integrated transit and land-use strategies.

Evolution of BRT

The concept of bus rapid transit is not new. Plans and studies for various BRT-type alternatives have been prepared since the 1930s, although there has been a greater emphasis on BRT in recent years than ever before.

Major Proposals

BRT proposals were developed for Chicago in 1937, Washington D.C. in 1956-1959, St. Louis in 1959, and Milwaukee in 1971. A brief discussion of these plans follows.

1937 Chicago Plan. The concept of bus rapid transit was first suggested in Chicago (Harrington, Kelker, and DeLeuw 1937). A 1937 plan (Figure 2) called for converting three west-side rail rapid transit lines to express bus operation on superhighways with on-street distribution in central areas and downtown.

1955–1959 Washington D.C. Plan. Design studies for BRT within freeway medians were developed as part of the 1956–1959 Transportation Survey for the National Capital Region (Mass Transportation Survey 1959). It was recommended that

in planning of future radial freeways a cross section . . . be provided to afford maximum flexibility and reserve capacity for vehicles as well as for the mass movement of people. Under this plan there would be a three- or four-lane roadway for traffic in each direction. These roadways would be separated by a 64-foot mall with 51 feet from center-to-center of the columns supporting cross-street bridges. In the first stage, this wide mall would be landscaped and held available for

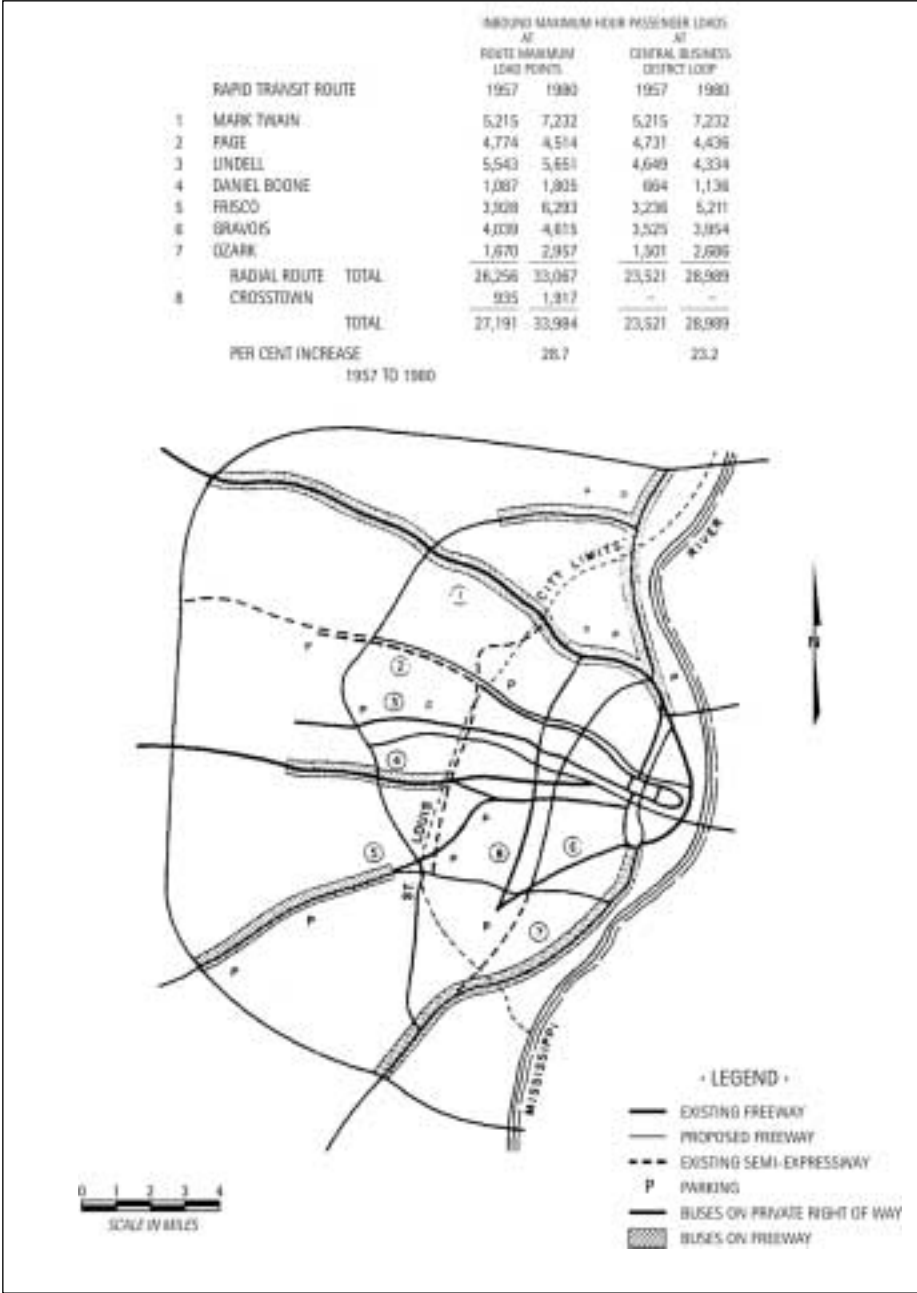

Figure 3. Proposed Regional Bus Rapid Transit Plan—St. Louis, 1959

future developments; public transportation would consist of express buses operating in the general traffic lanes. They would make stops at appropriate intervals on the parallel service roads without special station facilities or at simple stations within the end span of the cross-street bridges.

Express bus service eventually would be converted to BRT and rail within the median.

1959 St. Louis Plan. The 1959 Transportation Plan included an 86-mile BRT system, of which 42 miles were to be on special grade-separated bus roadways (W. C. Gilman and Co. 1959). Figure 3 shows the arrangement of the proposed busways and BRT lines. The focus of this proposal was an elevated loop road encircling part of downtown St. Louis, measuring six blocks north and south and five blocks east and west. The loop contained a 60-foot-wide operating deck that included a sidewalk, or passenger-loading platform, located on the inner side of the deck to mesh with one-way clockwise operation of buses. It provided a three-lane bus roadway approximately 37 feet wide. The BRT system cost totaled \$175 million (exclusive of freeways).

1970 Milwaukee Transitway Plan. Milwaukee's proposed 1990 Transitway Plan included 107 miles of express bus routes over the freeway system plus an 8-mile east-west transitway (Barton-Aschman Associates 1971). The plan, shown in Figure 4, called for 39 stations (excluding downtown) and 33,000 parking spaces. During the 1990 design-hour, 600 buses would enter the Milwaukee CBD as compared with 135 in 1973. Costs for the BRT transit system were estimated at \$151 million (1970) of which \$40 million were for the transitway. The plan was integrated with existing and proposed freeways.

Concept Studies

Several planning research studies have described the parameters where BRT would work and how it might be configured.

Transportation and Parking for Tomorrow's Cities. This 1966 study set forth broad planning guidelines (Wilbur Smith and Associates 1966). It indicated that bus rapid transit is especially suitable in cities where downtown most attracts its visitors from a wide, diffused area. It stated:

BRT could involve lower capital costs, provide greater coverage, better serve low- and medium-density areas, and more readily adapt to

changing land-use and population patterns than rail systems. BRT also has applicability in larger cities of much higher density because of its operational flexibility, and that with proper downtown terminal design, bus rapid transit systems could provide adequate capacities to meet corridor demands in nearly all of the Nation's cities which did not have rail systems.

To achieve high average speeds on downtown approaches, buses could operate within reserved lanes or exclusive freeway rights-of-way on key radial routes and travel outward to the intermediate freeway loop, with provision for subsequent expansion (Figure 5). Downtown, buses would operate preferably on private rights-of-way and penetrate the heart of the core area (either above or below ground) or, alternatively, they could enter terminals.

Successful BRT, however, would require

. . . careful coordination between highway and transit officials in all stages of major facility planning. In this regard, resolution of several major policy questions will go far toward early implementation of BRT systems. These questions include:

- 1. extent to which exclusive bus facilities will qualify for federal aid under existing programs,*
- 2. need for separate designs on approaches to the inner freeway loops and downtown,*
- 3. minimization or elimination of costly ventilation systems to facilitate underground operation,*
- 4. development of financing policies for downtown bus tunnels, and*
- 5. development of bus trains or special bus designs to minimize downtown station requirements and expedite downtown loading.*

The report indicated that a small amount of special right-of-way in conjunction with the urban freeway system (where necessary to assure good peak-hour speeds) could generally provide effective regional rapid transit.

It was conservatively estimated that freeways, BRT, local transit, and arterials under existing capabilities of cars and buses could accommodate peak-hour



Figure 4. Proposed 1990 Milwaukee Transitway Plan

downtown cordon volumes of up to 125,000 persons—ample capacity for the vast majority of the nation’s cores. Moreover, as bus technology improves and electronic bus train operation becomes a reality, substantially greater capacities would be achieved. “Thus, ultimately, differences between rail and bus transit could become minimal.”

The Potential for Bus Rapid Transit. This 1970 study indicated that free-way systems are potentially usable by express buses and, with modification, for exclusive bus lanes or busways (Wilbur Smith and Associates 1970). Key factors in evaluating the potential benefits of BRT include: (1) capital costs, (2) operating costs, (3) route configuration, and (4) distribution in the city center and other major activity centers.

NCHRP Reports 143 and 155 (1973, 1975) on Bus Use of Highways. These reports provided a comprehensive review of the state of the art and set forth planning and design guidelines (Levinson et al. 1973, 1975). Using the goal of minimizing total-person delay as a guide, these reports suggested ranges in peak-hour bus volumes for bus priority facilities. The guidelines, shown in Table 1, were based on “design year” peak-hour bus volumes.

Figure 6 shows the range in BRT service concepts set forth in Report 155 that are still relevant today.

Bus Rapid Transit Options for Densely Developed Areas. This 1975 study (Wilbur Smith and Associates 1975) described and evaluated the cost, service, and environmental implications of bus lanes, bus streets, and busways. The report showed how various bus priority facilities would be coordinated in the central area (Figure 7) and suggested a multidoor articulated bus for BRT operations.

Most of these concept studies focused on the facility aspects of BRT, often as an adjacent to urban freeways. Little attention was given to the service and amenity/identify aspects of BRT.

Countervailing Trends

In the late 1970s, the emphasis in transit planning shifted from bus use of highways and BRT to HOV lanes and LRT. HOV lanes were perceived as having widespread application as an environmentally positive way of expanding

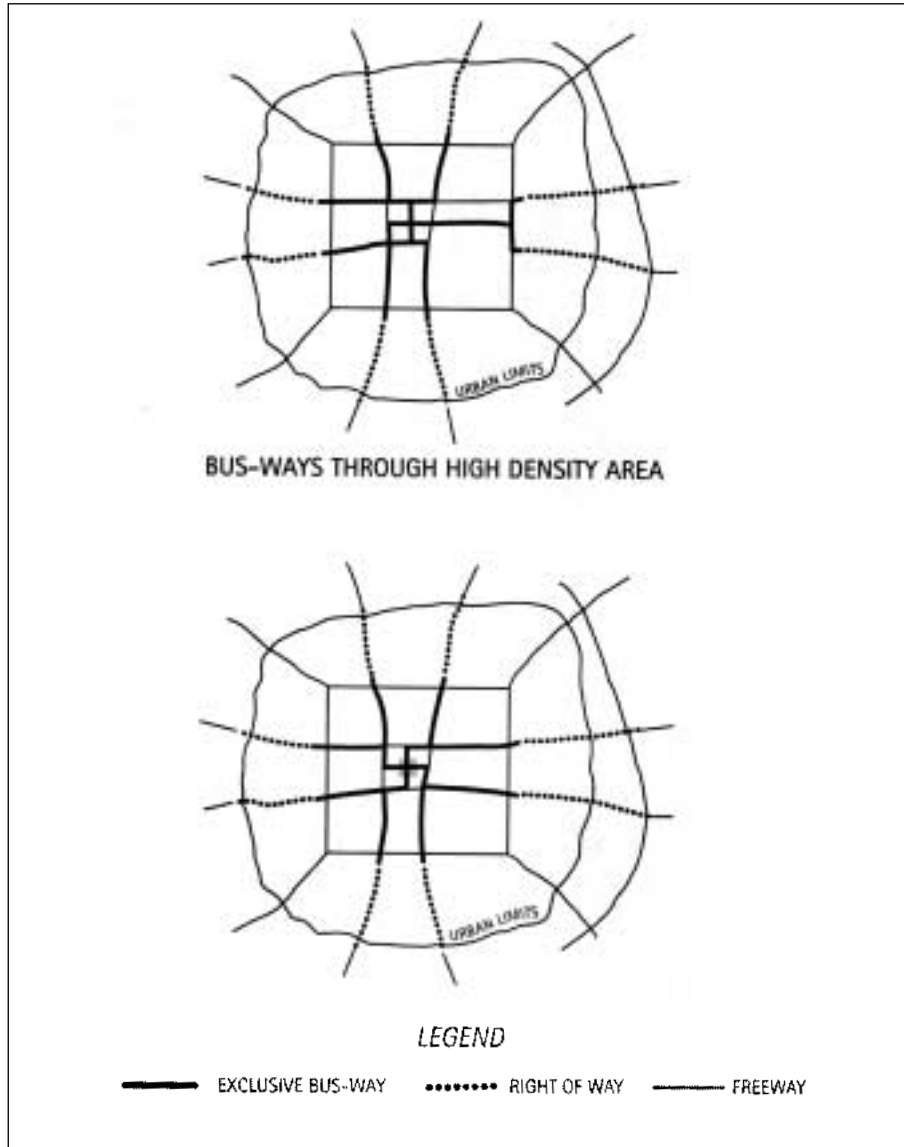
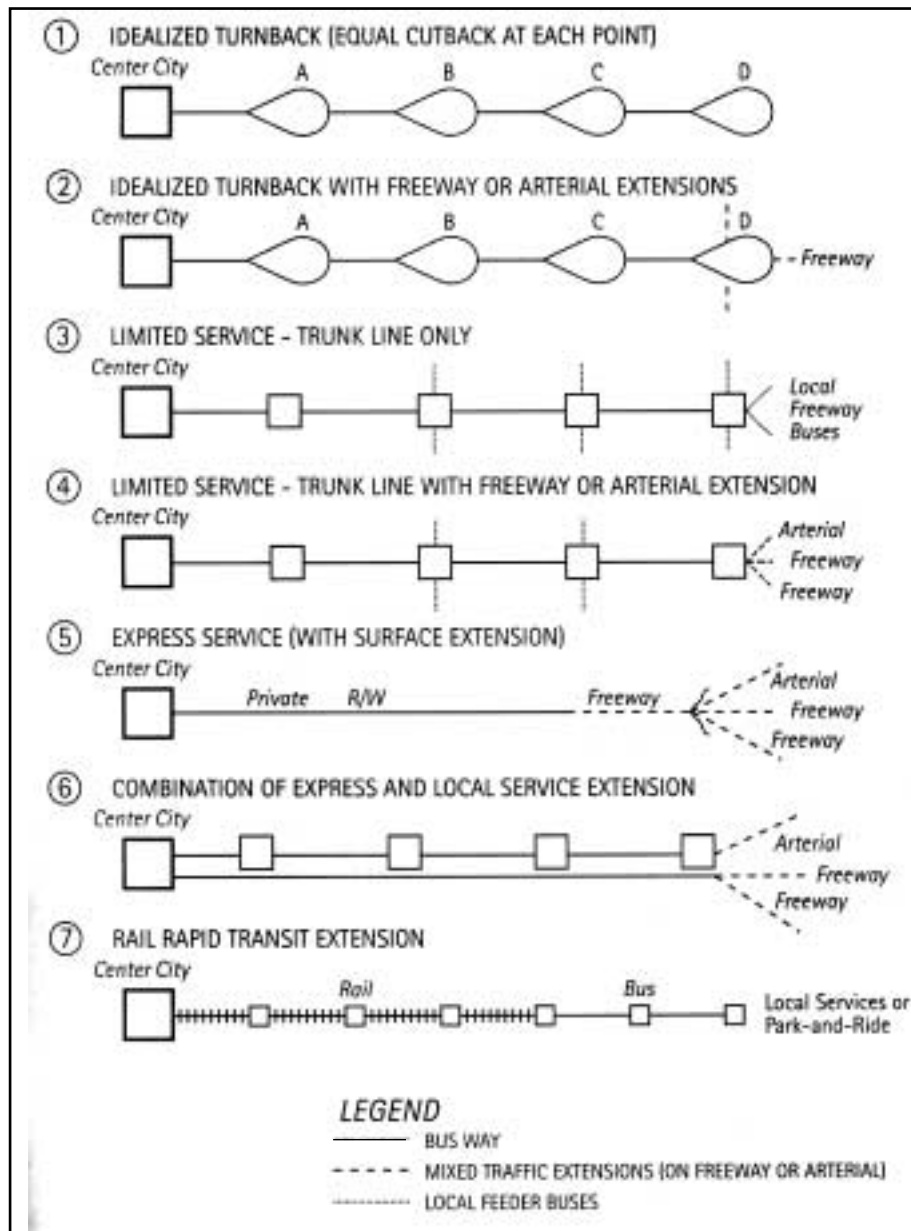

Figure 5. Configuration of hypothetical BRT systems

These schematic systems show how a relatively small mileage of special bus rights-of way can provide areawide rapid transit by utilizing freeway systems as an integral part of their operation. Radial freeways could provide amply wide medians to permit extension of bus-lanes (or rights-of-way) as required by future growth. Off-street bus-ways penetrate the heart of downtown and (where feasible) high-density areas. In some cases, metering of freeway traffic might serve as an alternative to exclusive lanes.

Table 1 Suggested Ranges in Peak-Hour (One-Way) Bus Volumes for Bus Priority Facilities	
<i>Type of Treatment</i>	<i>No. of Design-Year Buses^a</i>
Freeway-related:	
Busway	40–60 ^b
Contra-flow bus lane	40–60 ^c
Bus bypass lane at metered ramp	10–15
Arterial-related: ^d	
Bus streets ^e	20–30
CBD curb lanes, main street ^e	20–30
Curb lanes	30–40
Median bus lanes	60–90
Contra-flow bus lanes, extended	40–60
Contra-flow bus lanes, short segments	20–30
<p>a. Existing conditions should meet 75 percent of these volumes.</p> <p>b. Busway installation should generally be contingent on a CBD employment of at least 50,000, 20 million square feet of floor space downtown, and a metropolitan population of at least 750,000.</p> <p>c. Contra-flow bus lanes are contingent on directional imbalances in traffic volumes.</p> <p>d. Where arterial bus volumes are less than 60 per hour, taxis may use bus lanes.</p> <p>e. Environmental considerations may influence bus lane and bus street installation.</p>	

road capacity while reducing single-occupant vehicle (SOV) use. LRT lines were increasingly popular, in part, because they were perceived to have performance, quality, image, and service attractiveness that were unattainable by bus transit. While a few communities built busways and operated successful BRT lines over them (e.g., Ottawa and Pittsburgh), LRT was the favored mode, often to the exclusion of serious, objective consideration of BRT or other types of significant bus improvements in federally required planning processes.



Source: NCHRP 155.

Figure 6. BRT operating concepts

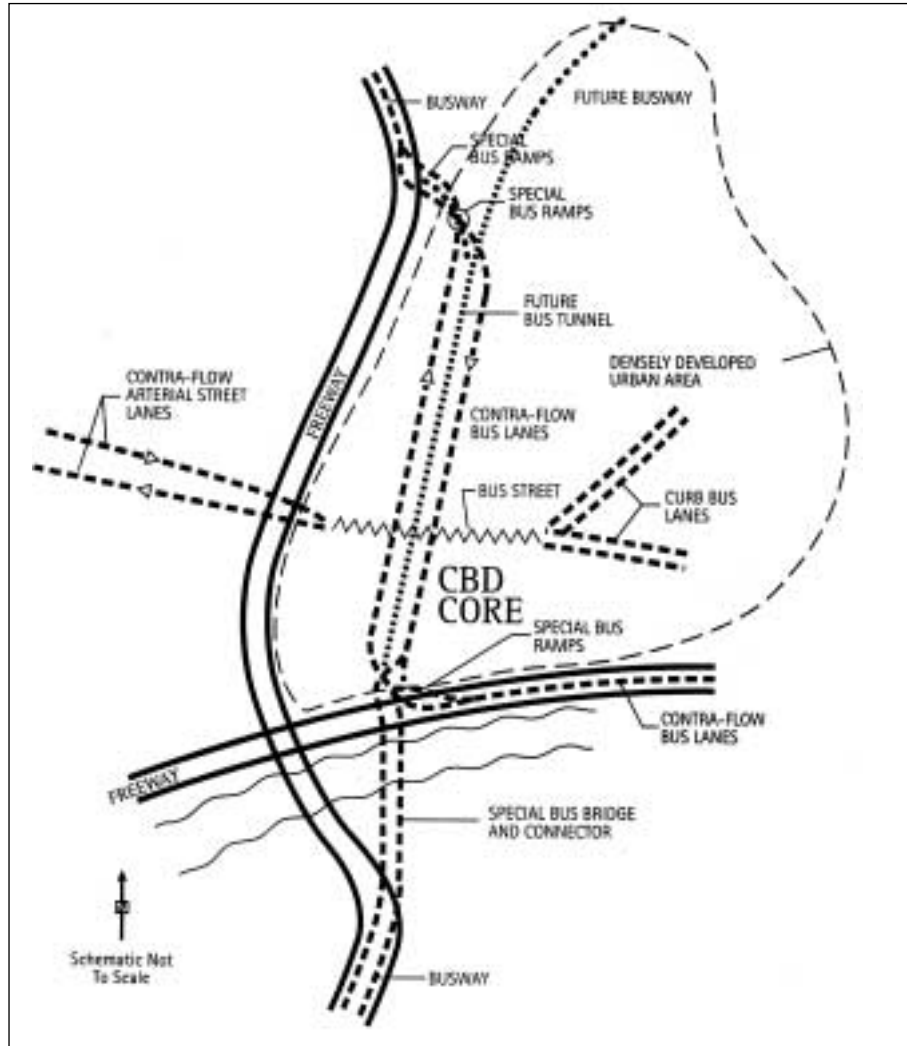

Figure 7. Illustrative coordination of bus priority facilities

Recent Initiatives

The federal BRT initiative is a major attempt to redress this balance. Initially using Curitiba’s successful BRT system as a “model,” the FTA sponsored a BRT conference in 1998, published major documents highlighting BRT (Federal Transit Administration 1987, 1990), established a BRT Consortium (1999) with 17 supporting cities, and launched a BRT demonstration program.

Concurrently, TCRP A-23 project “Implementation Guidelines for Bus Rapid Transit” was launched by the TCRP.

Current Status of BRT Implementation

BRT systems now operate in major cities throughout North America, Europe, Latin America, Australia, and New Zealand.

United States and Canada

About 20 BRT systems are in service, under construction, or in planning in the United States and Canada (Figure 8). These systems vary widely in extent, components, design and operating features, usage, costs, and benefits. Ottawa and Pittsburgh have the most extensive and heavily utilized busway systems that provide service through the city center. Both operate express and all-stop services, and both have experienced development along the busways. The following sections provide a summary of the most advanced BRT projects in the United States and Canada.

Ottawa. The Ottawa transitway system was implemented in phases since 1982. It includes 15.5 miles of exclusive busway, 7.5 miles of lanes on roadway, and 2 miles of downtown bus-only lanes. Twenty-two stations are located along the transitway; and park-and-ride lots at the ends of the facility contain approximately 2,200 spaces.

A variety of transit services are operated on the Ottawa transitway. An all-stops, local bus route operates exclusively on the transitway, much like a rail system. Other routes start in neighborhood areas and then access the facility for an express run for a major portion of their trip. Approximately 50 routes provide residents with peak-period, transfer-free express service; off-peak many of these routes operate as feeders to all-stop local routes.

The transitway carries approximately 200,000 riders daily, about 10,000 one-way in the A.M. peak hour at the maximum load point.

Pittsburgh. This City has three busways in operation. The South Busway, opened in 1977, is approximately 4 miles in length and includes nine stations. Buses share a right-of-way through the Mount Washington Tunnel in the Palm Garden Station area with light-rail vehicles. The 6.8-mile Martin Luther King East Busway, opened in 1983, is located on an existing right-of-way and

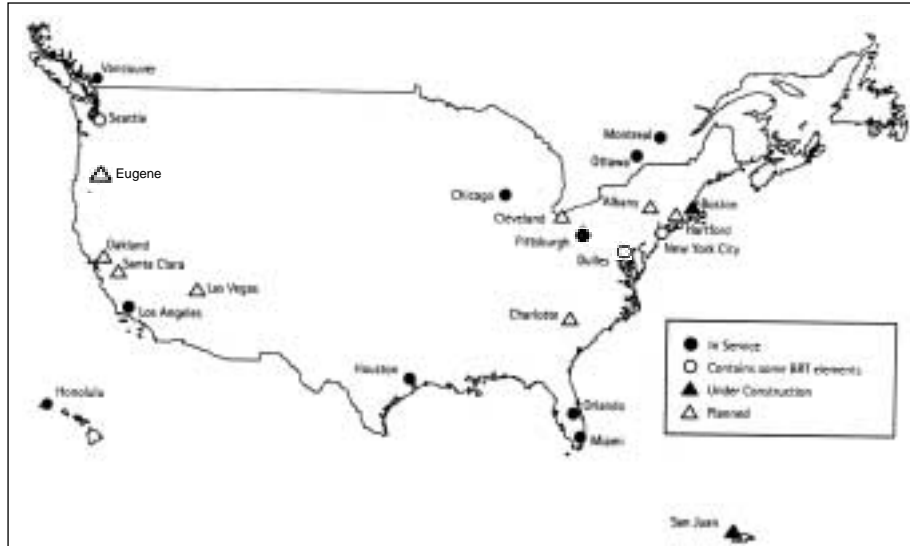

Figure 8. U.S. and Canadian BRT systems

includes six stations. The 5-mile West Busway, opened in September 2000, is also located on a former railroad right-of-way and has six stations. Approximately 2,800 additional parking spaces are provided in park-and-ride lots, including four near the busway. The East and West Busways operate both express and all-stop local services. Weekday ridership averages 28,600 on the East Busway, about 15,000 on the South Busway, and 8,000 trips on the West Busway (expected to rise substantially when 2,000 parking spaces, currently under construction, open).

Miami. Miami has a busway (South Dade) along an abandoned rail line that connects with the Metro rail line and carries about 14,000 weekday riders. Both express and local services are provided along the busway.

Montreal. This City has a feeder BRT line (via a reversible arterial bus lane) that connects to the Pie IX Metro rapid transit station.

Houston. An extensive system of commuter express service operates via bus/HOV lanes with special dedicated “T” access ramps connecting to park-and-ride lots. Downtown distribution is via curb-bus lanes.

Los Angeles. This City operates the MetroRapid Bus service on Wilshire–Whittier and Ventura Boulevards. Both routes are easily identifiable

with red-colored low-flow, low-pollution buses running limited-stop service from farside stations (local route use nearside stops) (Figure 9).

MetroRapid buses serve as extensions of the Red Line subway both to the San Fernando Valley (via Ventura Boulevard from the Universal City Metrorail Station) and west on Wilshire Boulevard from the Vermont station. Buses can extend or advance the green time at selected traffic signals. Operating speeds have increased about 29 percent in the Wilshire–Whittier corridor and ridership has increased by 33 percent. In the Ventura Boulevard corridor, operating speeds increased by 23 percent and ridership grew by roughly 26 percent. One-third to one-half of the increased ridership comes from riders new to transit (Metropolitan Transportation Authority 2000). Two-thirds of the travel time savings result from the wider stop spacing.

Vancouver. The 98-B Line BRT between downtown Vancouver and Richmond uses multidoor, low-floor articulated buses. The BRT lines operate with limited stops, feature attractively designed stations, and use a bus-only street in Richmond (Figure 10). Vancouver's 99-B line provides a similar crosstown service from east to west.

Seattle. A bus-only subway runs through Seattle's CBD. Dual-mode articulated buses provide local and express service in outlying areas via freeways and HOV lanes. Some buses run on express service via I-5 to the north and then connect to a short busway running south.

Boston. Boston's Silver Line South Piers Transitway, which is currently under construction, will include both curb bus lanes and a bus subway. Viewed as a fifth rapid transit line using special dual-mode (electric trolley and full-power diesel) articulated multidoor vehicle, it will link the South Station (Red Line Subway, commuter rail, Amtrak, and intercity bus) and Financial District with the South Piers and Dudley Square on the MBTA's Orange Subway Line. BRT express service will also extend over the existing Ted Williams Tunnel to Logan International Airport (Figure 11).

Overseas Experience

A broad range of BRT systems and features are found in South America, Europe, and Australia.



Figure 9. Bus stop, MetroRapid, Los Angeles



Figure 10. Vancouver's BRT lines operate with limited stops, feature attractive stations, and use a bus-only street in Richmond.



Figure 11. Boston's BRT express service will extend over the existing Ted Williams Tunnel to Logan National Airport.

South America. Major BRT systems have been implemented in Belo Horizonte, Curitiba, and São Paulo, Brazil; Quito, Ecuador; and Bogotá, Colombia. These systems typically use physically separated median lanes along wide multilane arterial roadways. Stations are typically spaced 1,200 to 1,500 feet between major intersections, with provisions for overtaking on some systems via passing lanes at stations. Multidoor articulated (18 meter) and biarticulated (24.5 meter) diesel and trolley buses are used, depending on the system, and several systems offer off-vehicle fare collection. Peak-hour, peak-direction passenger flows range from 10,000 to 20,000 persons per hour (Gordon, Cornwell, and Cracknell 1991).

Of these systems, the Curitiba operation is perhaps the best known. Curitiba's BRT system is an integral part of the City's development strategy, and it is carefully integrated with adjacent development. Biarticulated buses operate in a median busway that is flanked by local service streets. In addition, express buses run on two parallel high-capacity one-way streets.

The BRT stations in Curitiba are located in “plastic tubes” with high-level platforms that match the floor height of the BRT buses. The stations also feature off-vehicle fare collection at the ends of the tubes to expedite passenger flows and reduce dwell times. However, station and vehicle design limit bus operations to the median busways.

The twelve key attributes of the Curitiba system include:

1. simple route structure,
2. frequent service at all times of day,
3. headway-based as opposed to time-point schedules,
4. less frequent stops,
5. level boarding and alighting,
6. color-coded buses and stations,
7. exclusive lanes,
8. higher-capacity buses,
9. multiple-door boarding and alighting,
10. off-vehicle fare payment,
11. feeder bus network, and
12. coordinated land-use planning.

Curitiba’s busways carry about 188,000 daily passengers in the north-south corridor, 80,000 in the Boqueirao corridor, 52,000 in the east corridor, and 19,000 in the west corridor. The highest, peak-hour, peak-direction ridership is approximately 11,000 in the north-south corridor.

Europe. European BRT systems have several innovative features. Essen, Germany, and Leeds, England, have mechanically guided busways. Rouen, France, has an optically guided busway that uses the Irisbus Civis dual-mode diesel-electric bus (Figure 12). In Runcorn, England, the entire town is built around a largely grade-separated busway system.

Australia. Brisbane’s South East Busway’s attractive stations have received architectural awards for their innovative design (Figure 13). Only two years after the first segment opened, the (US) \$200 million 10.5-mile busway carries more



Figure 12. Rouen's optically-guided busway uses the Irisbus Civis dual-mode diesel-electric bus.

than 60,000 riders per day and has induced three major joint development projects (one already completed) as well as an increase in residential land values near stations 20 percent higher than similar areas not within walking distance of stations.

Adelaide operates a mechanically guided busway that enabled an elevated transit structure to be built with minimum width and cost. The 7.4-mile guided Adelaide busway, opened in stages between 1986 and 1989, has three major stations, carries 20,000 daily riders, and planning is underway for its expansion. During peak periods, buses operate through suburban neighborhoods and then access the busway for a high-speed, express run to the urban core. During off-peak periods, some routes only provide feeder service to an on-line, all-stops local route.

Lessons Learned

Comparison of the examples described above demonstrates a number of similar attributes. Several lessons can be drawn from the case studies, many of which were conducted as part of the TCRP A-23 project on "Planning and Implementation Guidelines for Bus Rapid Transit." The major lessons learned can be organized into the following categories:

- planning and project development process,
- system concepts and packaging,
- running ways,
- stations,
- vehicles,
- system identity and image,
- service plan,
- ITS applications, and
- fare collection

Many of the lessons learned apply to planning and implementation for any rapid transit mode even though they were derived from the synthesis of BRT experience.

Planning and Project Development Process

Early and continued community support for an open planning process that objectively considers BRT is essential, particularly from elected leaders. It is important that decision-makers and the general community understand the nature of BRT and its potential benefits during the planning process and not assume that BRT is just additional bus service. BRT's potential performance, customer and developer attractiveness, operating flexibility, capacities, and costs should be clearly identified in alternatives analyses that objectively consider other alternatives as well.

The key rapid transit planning issue in many urban environments is how best to match market needs with available rights-of-way, not necessarily what mode to use. Accordingly, BRT system development should be the outgrowth of a planning and project development process that stresses problem solving and addresses demonstrated needs, rather than advocating a particular solution.

Successful BRT implementation usually requires participation of more than just transit operator/implementers. All prospective actors, especially highway implementer/operators should be a formal part of the planning process. For example, participants may include representatives of private sector transit operators as well as the police departments that may ultimately be responsible for



Figure 13. BRT stations Brisbane: South East Busway

enforcing exclusive transit running ways, as well as the safety and security of transit workers and customers.

BRT and land-use planning for station areas should be integrated as early as possible. Ottawa, Pittsburgh, Brisbane, and Curitiba have demonstrated that BRT can have land-use benefits similar to those produced by rail rapid. Realizing these benefits requires close coordination of land-use and transport planning from the beginning.

In many cases, it may be useful to identify a BRT segment for immediate, early implementation. This will demonstrate BRT's potential benefits as soon as possible at an affordable cost while enabling system expansion and upgrading (e.g., to more technologically advanced, dedicated BRT vehicles) at some future time.

System Concepts and Packaging

A successful BRT project that achieves its full potential calls for more than building or reserving a bus-only lane or even building a dedicated busway. The integration of the entire range of rapid transit elements, including stations, and development of a unique system image and identify are equally, if not more, important.

BRT systems, like any rapid transit system, should be designed to be as cost-effective as possible. However, transportation planners should not “cut corners” by eliminating key system elements and their integration merely because it would still be possible to attain minimal functionality of the bus system. This will greatly reduce potential benefits that can be achieved by a fully integrated BRT system.

It is essential that BRT systems include all the elements of any high-quality, high-performance rapid transit system. These elements should be adapted to BRT’s unique characteristics, especially its service and implementation flexibility. There is a need to focus on service, station, and vehicle features and amenities and integrated system and “image” benefits, rather than merely costs. Bus rapid transit should be rapid. This best can be achieved by operating on exclusive traffic-free rights-of-way wherever possible, maintaining wide spacings between stations, and by minimizing dwell times at stops.

Running Ways

Though it is possible for buses to operate successfully in mixed traffic and even desirable for them to operate in bus or in HOV facilities in some markets, the ideal BRT system will operate over exclusive bus facilities for enhanced speed, reliability, and safety, and often overlooked, identity.

Railroad and freeway rights-of-way offer opportunities for relatively easy acquisition and low development costs. However, the availability of right-of-way should be balanced with its proximity and access to key transit markets.

Where a BRT commuter express service operates on an HOV facility, it is imperative that it have its own access/egress ramps to reach off-line transit stations and/or do collection/distribution in other ways. Requiring BRT vehicles to weave across multiple lanes of general traffic to access median HOV lanes should be avoided.

In identifying and designing BRT running ways, it is important to consider identity and image as well as speed and reliability.

The positive aspects of curb bus lanes are good pedestrian access and more manageable integration with turns at intersections. The negative aspects are delays from right-turning vehicles and competing use of curb space by delivery and service vehicles.

The positive aspects of median BRT facilities on arterial streets are identity, avoidance of interference with access to adjacent land uses, and minimum “side” impedance. Wide streets are needed to accommodate BRT service along with general vehicular traffic. The negative aspects are interference with left turns and potential pedestrian access problems, which sometimes may be alleviated by special traffic signal phasing sequences.

Stations

Stations are perhaps the most critical element in achieving system identity and image.

Safe pedestrian and auto access to BRT stations is critical to achieving ridership objectives. Context-sensitive design and community involvement will both ease BRT implementation and induce transit-oriented land-use development.

Off-vehicle fare collection and suitable passenger amenities are desirable at major boarding points.

Vehicles

Vehicles are an important element of conveying system identity and image. There is general recognition of the need for greater focus on vehicle quality and identity for BRT systems, especially in the United States. Several manufacturers, such as Irisbus, Bombardier, and Neoplan, are starting to recognize this need by producing special BRT vehicles.

BRT vehicles should be configured to specific BRT applications as to number and width of doors, internal layout, etc. In the case of BRT systems, one size definitely does not fit all.

Focus should be placed on customers, both on- and off-board, by designing for ease of passenger entry/egress, on-board comfort, and cleaner air and noise emissions.

It is desirable to operate BRT systems with fleets of specially dedicated BRT vehicles.

System Identity and Image

System identity and image are important. As a minimum, they provide the customer with information on where to access the system and routing.

Identity and image alone can increase ridership in a competitive, consumer-oriented society.

Identity and image should be emphasized and be consistent in the design of all BRT system physical elements, including stations, vehicles, and running ways. Special graphics, livery, and construction materials can combine not only to convey useful information (e.g., where to catch a BRT service), but also to provide constant advertising exposure.

Service Plan

BRT service can extend beyond the limits of dedicated guideways where reliable, high-speed operations can be sustained. Outlying sections of BRT lines, and in some cases CBD distribution, can use existing roads and streets. These running ways should be modified to improve BRT efficiency, effectiveness, and identity through the use of graphics, signage, pavement markings, and appropriate traffic controls.

A key feature of BRT systems is their ability to provide point-to-point one-seat rides because of the relatively small size of their basic service unit compared to train-based modes. This, however, must be balanced against the need for easy-to-understand, high-frequency service patterns at all times of day.

In most North American urban corridor applications, the BRT service pattern that appears to work best features all-stop “LRT type” service at all times of day, complemented by an overlaid integrated local/express services for specific markets during peak periods, such as express service between major park-and-ride stations and the CBD. During off-peak periods, integrated local/express routes are turned back at BRT stations, converting the local portion of the routes into more cost-effective feeders.

Where transfers are necessary, they should take place in station facilities that are attractive, offer amenities, and are designed to minimize walking distances and level changes.

ITS Applications

ITS elements are critical to the success of BRT and can, at relatively modest cost, replace some of the functions provided by the physical infrastructure for other types of rapid transit. ITS elements can be used to convey passenger information in a variety of venues, monitor/control bus operations, provide priority at signalized intersections, enhance safety and security on board vehicles and at stations, and provide guidance for BRT vehicles.

In places where ITS elements have been applied most successfully to BRT, they have been applied as part of an integrated regional transportation system, as in Los Angeles.

Fare Collection

Off-board fare collection is desirable because it is more convenient for customers. It permits multiple-door boarding, thereby reducing station dwell times, passenger travel times, and bus operating costs.

Some on-board fare collection mechanisms can support multiple-door boarding, but they must be carefully selected. ITS or smart card technology applied at multiple doors may be the key to allowing simultaneous “on-board” fare payment and multiple-door boarding without increasing revenue shrinkage.

Significance and Extension

BRT does work! Recent developments around the world have shown that BRT systems can provide high-quality, high-performance, attractive rapid transit in a variety of settings. A growing number of cost-effective systems demonstrate the potential to produce significant service, ridership, and development benefits at relatively modest initial implementation and operating costs.

Looking ahead, there will be a growing number of fully integrated BRT applications, and even more use of selected elements. The recent introduction of attractive, flexible, rubber-tired, “dual-mode” purpose-built BRT vehicles into revenue service is likely to have a profound effect on accelerating the acceptance of BRT as a true rapid transit mode in a number of ways. First, these vehicles overcome the image and identity problems BRT has had because of its link to conventional local bus services, especially in North America. Second, with true dual-mode (steered like a bus or guided like a train) capabilities, they can deliver the real, substantive benefits of both buses and rail transit, especially when running way and service plan improvements are also made. The resulting flexibility makes BRT a candidate for consideration in many rapid transit applications. The flexibility is especially important in North America with its wide diversity of urban land development patterns and modest capacity requirements.

At the same time, all communities may not have sufficient ridership markets or have financial or physical limitations that prevent implementation of a

fully integrated BRT system. In those cases, many of the lessons learned concerning the individual components can be adopted by existing bus systems to improve their overall attractiveness and cost effectiveness.

References

BRT Bus Rapid Transit—Why more communities are choosing Bus Rapid Transit. 2001. Washington, DC: Transportation Research Board, National Research Council.

Federal Transit Administration. 1987. *Issues in Bus Rapid Transit*.

Federal Transit Administration. 1990. *Bus Rapid Transit demonstration program*.

Gordon, G., P. K. Cornwell, and J. A. Cracknell. 1991. *The performance of busway transit in developing countries*, Crowthorne, UK: Transport and Road Research Laboratory.

Harrington, P., R. F. Kelker, and C. E. DeLeuw. 1937. *A comprehensive local transportation plan for the City of Chicago*.

Levinson, H. S., et al. 1973, 1975. NCHRP Reports 143 and 155. *Bus Use of Highways*. Washington, DC: Highway Research Board, National Research Council.

Mass transportation survey—National capital region, civil engineering report. 1959. DeLeuw Cather & Co. (January).

Metropolitan Transportation Authority. 2000. *Final report*. Los Angeles Metro Rapid Demonstration Program.

Milwaukee area transit plan: A mass transit technical study. 1971. Barton-Aschman Associates (June).

Thomas, E. 2001. Presentation at Institute of Transportation Engineers meeting, Chicago (August).

W. C. Gilman and Co. 1959. *St. Louis metropolitan area transportation study*. Prepared for the City of St. Louis and St. Louis County (August).

Wilbur Smith and Associates. 1966. *Transportation and parking for tomorrow's cities*.

Wilbur Smith and Associates. 1970. *The potential for Bus Rapid Transit*.

Wilbur Smith and Associates. 1975. *Bus Rapid Transit options for densely developed areas*.

About the Authors

HERBERT S. LEVINSON (hslevinson@aol.com) is a transportation consultant who has worked for public agencies in the United States and abroad. He has written extensively on public transport, covering topics such as bus rapid transit, bus use of highways, transit operations, and transit capacity. Mr. Levinson is the coprincipal investigator for the TRB TCRP A-23 project on "Planning and Implementation Guidelines for Bus Rapid Transit Systems." He is a member of the National Academy of Engineering and an Urban Transportation Research Center mentor at City College, New York. He has a BS degree in civil engineering from Illinois Institute of Technology, and a certificate in highway traffic from Yale University.

SAMUEL ZIMMERMAN (sam.zimmerman@dmjmharris.com) is the principal for transportation planning for DMJM+Harris. Mr. Zimmerman is the coprincipal investigator for the TRB TCRP A-23 project. He is also the former director of planning for the Federal Transit Administration and has a career spanning 34 years in which his major interests have included travel demand forecasting, transit economics, and systems analysis. He has BCE and MCE degrees from Cornell University.

G. SCOTT RUTHERFORD (scottrut@u.washington.edu) is director of the transportation program and chairman of the civil engineering department at the University of Washington, where he has taught for more than 21 years. He received a Ph.D. in transportation from Northwestern University and has been a transportation planning consultant on numerous major transit projects. His specialties are travel demand forecasting, transit and traffic operations, and major transportation investment planning. Dr. Rutherford is a member of the TCRP A-23 project team.

JENNIFER CLINGER (jennifer.clinger@dmjmharris.com) is a senior transportation planner with DMJM+Harris, where she consults in the areas of transportation planning, economics, and finance. She is a member of the TCRP A-23 project team. Ms. Clinger holds a master's degree in regional planning from the University of North Carolina and a bachelor's degree in city planning from the University of Virginia.

Characteristics of Bus Rapid Transit Projects: An Overview

*James T. Jarzab, Commuter Associates
James Lightbody and Eugene Maeda
Santa Clara Valley Transportation Authority*

Abstract

During the previous century the public transit industry has struggled with mode and technology issues. Bus and rail have alternated in primacy as operating conditions and financial necessity have pressured operators to seek more cost-effective means of moving passengers. Federal, state, and local financial resources have been outstripped by candidate rapid transit projects, traffic congestion is a growing problem, and travel patterns are becoming increasingly dispersed. In seeking to fill the gap between conventional bus service and rail projects of all kinds, the transit industry in cooperation with the Federal Transit Administration (FTA) has placed renewed emphasis on the development of alternatives that reflect a return to the transportation system management approach. Equipped with new tools for improving operating and management productivity of highway and transit networks, transportation agencies are working cooperatively to simulate exclusive rights-of-way operations in mixed-traffic environments as well as meld the line-haul efficiencies of rail with the distribution flexibility of bus. These efforts are known collectively as Bus Rapid Transit (BRT), and as with any entity in its infancy, final appearances at maturity are far from certain.

Introduction

Within the last decade, the concepts of “bus service” and “rail service” have evolved with elements of their definitions blurring into a hybrid of characteristics between the two modes of transportation. In general, when one thinks of “bus” it evokes an image of a single-unit, elongated vehicle with a driver collecting fares and manually steering the rubber-tired vehicle on concrete or asphalt pavement along a predetermined route and time schedule in mixed traffic. Alternatively, the thought of “rail” produces an image of multiple-unit train cars with a conductor who has human or mechanical assistance collecting fares, and whose steering is guided by parallel tracks with the vehicle riding on steel wheels. Advancements in technology—particularly those involving Intelligent Transportation Systems (ITS)—have altered these images and mode characteristics. In combination with the growing concern of forecast population growth, land development intensification, traffic congestion, and associated pollution, communities have been looking for new and innovative approaches to address the issue of metropolitan mobility. One option that has recently been gaining attention and popularity is BRT.

BRT is the latest “buzz word” within the public transit community and has been promoted as the economic and practical solution to improving existing public transit systems. But exactly what is BRT? In initial appearance, BRT looks like a light rail system but physically operates like a bus. Although several BRT-like systems exist in North America, these systems defy easy comparison. And, while many professionals within the public transit community are familiar with or at least have heard of some of the more common characteristics of BRT and, perhaps the most-referenced BRT system, the BRT system in Curitiba, Brazil, there is still some question as to what distinguishes BRT from conventional bus systems.

During the past few years, federal, state, and local transportation agencies as well as various transportation professional associations within the United States have been collaborating to clearly define BRT for the purpose of educating the public and elected officials. This effort is essential for promoting the benefits of the BRT mode in addition to establishing criterion for funding in a very competitive environment.

Purpose

This article observes and explores the characteristics and current applications of BRT projects as a mode of public transportation. The scope includes a comparison between BRT and light rail, a discussion on the definition and characteristics of BRT projects, and observations on current applications and effectiveness of BRT projects.

Bus Versus Light Rail

Some may find it amusing that in the discussion of bus versus rail, the respective modes have been considered superior to their counterparts during various periods of development. When first developed, rail service was a marked improvement over transportation by highway in terms of cost, comfort, speed, and reliability. Among a variety of reasons, increased traffic congestion in urban areas prompted a return to prominence for buses in the mid-20th century, but like a pendulum, declining bus service quality and urban redevelopment aspirations put rail service (now in exclusive rights-of-way) back into the spotlight. Even so, high capital and maintenance costs for rail projects have prompted a renaissance of bus-based transit projects.

Concepts commonly thought of as characterizing BRT in the United States have been discussed for over half a century. Transportation agencies in the 1950s were already looking for ways to implement a higher quality, lower-cost “rail-like” transit service (California Public Utilities Commission 1957), and the limited opportunity to identify or create exclusive rights-of-way has turned this interest into ongoing explorations (Crain 1963).

Those familiar with current transit bus operations may find the phrase “BRT” a bit of an oxymoron. The reason is that the average conventional bus route in revenue service tends to operate at half the speed of general traffic when it shares rights-of-way in arterial operation. Though improvements such as “express” or “limited” services have been implemented in some fashion by almost all transit agencies, many bus routes still operate in shared right-of-way environments and are subject to the standard cycling of traffic signals. Indeed, there has been considerable effort on the part of the transit industry to move beyond bus service as the primary medium-capacity service delivery mode

with the introduction of light rail systems, which are perceived to be less intrusive than heavy rail and yet have increased capacity and speed over bus. In addition, light rail has attractiveness as a tool for transit-oriented development, a characteristic not convincingly displayed by bus service of any type.

The federal funding category of “New Starts” has essentially been the exclusive domain of rail service since its inception. For the most part, bus operations have been relegated to the mundane workhorse of the transit industry, the “one-size-fits-all” service offered throughout the United States. Even so, the flexibility of bus also has its advantage: buses sharing rights-of-way with general traffic provide the opportunity to dedicate scarce public resources where most productive versus the high cost of initiating light rail services (U.S. Department of Transportation 1989). This is particularly the case in markets where the superior operating characteristics for multiunit consists provided by exclusive rights-of-way are not essential. The ability to maneuver around temporary obstacles offers the opportunity to maintain schedule adherence where grade separation from general traffic is not feasible. While buses can and do take advantage of exclusive right-of-way and grade separation, conceptually they provide excellent performance in mixed traffic where light rail cannot operate as effectively. Therefore, BRT may (or may not) involve the use of exclusive rights-of-way, may (or may not) involve the use of transit signal priority, and may (or may not) benefit from the use of automated vehicle identification (AVI) and/or location technologies. Regardless of the mix of features present, BRT projects are designed to operate much faster and more reliably than conventional bus transit systems (Federal Transit Administration 2001).

In a majority of instances where political necessity warrants high-capacity transit consideration (i.e., light or heavy rail), exclusive right-of-way may be unattainable (at least within any given project’s available budget). With consideration toward Transportation System Management (TSM), the industry is increasingly examining means of using off-the-shelf technology to enhance the performance of transit vehicles operating in mixed traffic. The use of computer technology to increase the sophistication of traffic control devices, improve fleet management, and provide real-time passenger information has dramatically broadened the potential for optimizing bus operations, reducing operating costs,

and adding value to the travel time spent “ridesharing” in transit vehicles. These advances provide an opportunity to change the public’s perception of bus service and increase system efficiency and effectiveness in the bargain.

Bus service usually competes for commuters and other customers at a significant operating disadvantage when compared to the automobile. Stopping frequently and having to maneuver in and out of the mainstream traffic flow (which is usually occupied by drivers with little incentive to let them in), traditional intraurban bus services are perceived by the public as being too “slow and unreliable” for traveling consideration. The same circumstances affect streetcars with their restricted lateral movement in the face of obstacles. However, with enhancements, such as exclusive rights-of-way, traffic signal preemption, and a formal station, the traditional streetcar effectively becomes a light rail or rapid transit service. These advances are perceived as a hallmark of multimodal success by many metropolitan areas. To a certain extent, such a transformation is currently being applied to traditional bus service with the implementation of BRT elements.

BRT Versus Light Rail Transit

For both bus and rail services, moving transit riders with a speed and reliability comparable to that of autos has focused transportation planning and programming efforts on providing exclusive rights-of-way and/or priority traffic signals. Separating transit service from the general traffic stream has always been the preferred solution for maintaining speed and schedule adherence. Unfortunately, physical space and financial capital are rarely available to take full advantage of the benefits of exclusive rights-of-way. When both are in equal abundance, the technical choice between bus and rail is often a matter of deciding whether the travel corridor warrants high capacity at the expense of distribution flexibility and/or whether sizable segments of project right-of-way can become operational simultaneously.

Project continuity is a major issue for rail rapid transit. For obvious reasons, rail projects tend to extend from a core segment to the system maintenance facility. This core segment normally includes a central business district (CBD) with high-density residential areas that generate a substantial portion of

the fully developed system's customer base; as such, completing this segment is essential to the successful implementation of the project. However, the very set of factors that makes the main corridor for rail services attractive (e.g., stations, park-and-ride lots, etc.) are those elements that typically involve substantial capital resources, experience significant environmental scrutiny, and are time-consuming to implement.

On the other hand, BRT projects can generally be completed in phases as funding and opportunity permit; because of service flexibility, even the core segment can be left for last. This incremental development provides an opportunity to show progress much earlier than with most rail projects. Ironically, local officials often view the flexibility of BRT service as a drawback. The "permanence" of rail right-of-way and station development is widely regarded as an irreversible public commitment to transit service capable of attracting private sector investment supportive of community development goals and objectives (Buckley and Miller 2000).

BRT on exclusive right-of-way does not markedly differ from rail rapid transit. In most applications, boarding areas are formally developed into stations complete with passenger flow control and off-vehicle fare collection. Grade separation and crossing protection from street traffic are usually provided in either instance. One of the biggest limitations of rail service versus bus service is the high cost of distributing passengers to their ultimate destinations. As experienced by many rail rapid transit operations before World War II, the expense of operating branch-line service to neighborhoods often outweighed the revenue generated for the system by those branch lines (Federal Transit Administration 1994).

In addition, the cost of maintenance for lightly used branch lines is only marginally less than that for heavily used mainlines, a fact not lost on commuter or freight railroad management. Rail transit operators rely on feeder bus services to provide this distribution, but time and financial transfer penalties dampen the attractiveness of the multiple-seat ride and foster the proliferation of park-and-ride lots. BRT operations can overcome some transfer problems by operating branch service on local streets directly to the mainline. In general,

densely developed linear corridors with readily available exclusive rights-of-way are better suited for rail rapid transit than BRT.

In practice, it would appear that the effectiveness of BRT applications using advanced signal in mixed traffic exceeds the potential effectiveness for light rail transit (LRT) operating in the same environment. In these corridors, operating in mixed traffic may be inevitable, and mixed-traffic operation is within the domain of BRT. Given the prevailing political and financial climate, exclusive guideway operations are often out of reach of most transit agencies, even for those corridors with the heavy transit demands. Advances in automatic vehicle location (AVL) and traffic signal technology offer opportunities to reduce traffic overflowing into residential areas from the major arterial roads. The primary difficulty is not in the application of ITS; rather, the greatest problems will be encountered when structural changes required of transit organizations to effectively deploy the technology and properly market the service are implemented.

To better compete with auto vehicles for mode share, transit services should adhere to scheduled performance parameters—whether by headways or by time point—and not run ahead of schedule. In the absence of exclusive rights-of-way, transit operators are subject to the same street traffic conditions as auto drivers. While auto drivers often have the ability to adjust to delays caused by nonrecurring events (e.g., traffic accidents, fire reroutes, etc.) through route deviation, transit operators are rarely afforded that opportunity. In its effort to compensate, traditional industry practice has been to add recovery time to the schedule. Excess recovery time often results in vehicles idling or operating at a reduced speed between time points for route deviation schedule adherence, negatively impacting vehicle productivity and increasing the cost of transit operations. This simultaneously dampens demand for discretionary transit trips, adversely affecting both ridership and revenue.

The implementation of bus signal priority offers an opportunity for transit operators to maintain both competitive operating speeds and on-time performance. Traffic signal cycles can be adjusted at strategic intersections along a route to provide consistent and predictable movement for transit vehicles in

a manner that is transparent to the public. This procedure has the potential to increase average operating speed and reduce overall travel time for transit patrons. However, signal priority alone does not guarantee on-time performance and schedule adherence. To implement these features, transit signal priority needs to be provided on a more selective basis and only activated when the transit vehicle is operating behind schedule.

Investment in exclusive right-of-ways or ITS technology does not necessarily make for a successful BRT system. Another key element to successfully implementing BRT is marketing. The purpose of marketing is to distinguish BRT from conventional bus service. The marketing for and branding of BRT appears to influence how the public, the press, and elected officials will respond to the service and future flexibility in establishing price points. In addition, size and appearance apparently does matter for BRT.

Reciting a litany echoed by customers, planners, and politicians, transit agencies want BRT buses to appear more rail-like. When translated into steered, rubber-tired transit applications, several of the vehicle designs regularly cited by transit planners and urban designers as being reflective of “rail-like” characteristics are streamlined in a fashion reminiscent of art deco steam locomotives. Such bus designs have gone beyond the utilitarian “boxy” look of buses, heavy rail, and light rail vehicles generally operating in North America. Vehicles receiving a great deal of attention for BRT applications are generally articulated with smooth aerodynamic silhouettes and large windows. An example is the Civis vehicle from Irisbus of France. Domestic and foreign manufacturers currently offer or are developing similar designs.

In its final project report, Metropolitan Transportation Authority (MTA) of Los Angeles identified marketing as one of the key strategies to successfully introducing its BRT program (Metro Rapid) along Ventura and Wilshire Boulevards, two of its most heavily traveled corridors (Los Angeles Metropolitan Transportation Authority 2001, p. 18). MTA also noted the need to differentiate its Metro Rapid bus service from the other public transit modes offered. Another reason for brand marketing is to inform transit riders of the difference in service along with distinguishing BRT vehicles from the standard bus service in “look” and “feel.” Specific examples are the branding and use

of different colors schemes, operation of articulated, low-emission and/or low-floor boarding buses, and use of electronic schedule signs and distinctive passenger shelters. Having passengers distinguish vehicles in advance of arrival reduces vehicle waiting time as passengers board and alight and minimizes potential liability exposure by encouraging orderly boarding at stops.

Like most goods and services, transit operations benefit from product differentiation. Product differentiation conveys to the public that services have been tailored to address particular travel needs. Product differentiation also allows for establishing separate service price points should the need arise. In addition, product differentiation allows ratepayers to readily perceive the investments made in services they may not regularly use or benefit from directly. Ever since public ownership became the norm in the United States, transit operators have spent considerable time and effort to standardize colors, logos, and paint schemes used on equipment and marketing material. This was particularly important during the 1970s, when changes in ownership and system consolidations were common as many transit operators were left with a mixture of equipment in varying states of repair and sporting an array of color schemes. The effort made to rationalize cost and equipment maintenance has left many transit agencies cautious when considering product differentiation.

However, advertising other products has always been a major part of transit operations. Car cards and, more recently, partial and full advertising wraps on both buses and rail vehicles have significantly altered the basic public presentation for most transit operations without adversely affecting corporate image. Across the transit industry, fixed-route service is usually distinguished from dial-a-ride by the size of vehicle, and more often than not, by the logo and service mark. Rail operations are clearly distinguished from bus by the technology.

Beyond the fact that the BRT program is expected to provide a faster, more highly reliable trip than conventional bus service, there are practical operational and political reasons to emphasize BRT's greater comfort and advanced features with the public. The difficulty encountered in conveying these service aspects largely reflects the minimal physical differentiation between service types when operating in mixed traffic.

The public transit industry has been collaborating with the FTA in an effort to define BRT characteristics. While not exhaustive, some key characteristics of BRT systems are identified below:

- *Running Ways:* BRT vehicles can operate practically in any traffic environment, but the provision of limited or exclusive use can give BRT its speed, reliability, and identity. BRT running ways can be operated almost anywhere: on abandoned rail lines, within a highway median, or on city streets. A few examples are exclusive transitways, high-occupancy vehicle (HOV) lanes, dedicated transit lanes, transit streets or malls, and queue bypass lanes.
- *Stations:* BRT stops can be distinguished from conventional bus service by using unique station design elements. Examples of BRT station elements are real-time vehicle arrival information, streamlined passenger shelter designs, specific paint schemes, and logos.
- *Vehicles:* BRT vehicles can have features that improve comfort, speed, and safety (e.g., low-floor and multiple double-wide doors to allow fast and convenient boarding, wide aisles to provide ease of passenger movement, etc.) in addition to having distinctive design, color, and graphics to provide a unique identity for vehicles in BRT service.
- *Service:* BRT systems should provide fast, frequent, and reliable service, with stops spacing of 1 mile or more.
- *Fare Collection:* BRT systems typically offer fast and efficient fare collection systems to speed boarding and increase convenience.
- *ITS:* BRT systems generally rely on advanced digital technologies to improve customer convenience, speed, reliability, and safety. Examples of ITS elements are AVI and AVL systems, bus signal priority, and closed circuit television monitoring of operations (Transportation Research Board 2000).

Clearly, the array of features identified above need not be unique to BRT. However, because they are not yet widely available in conventional bus services, the introduction of several elements can significantly set apart BRT from other operations in a transit system.

A Sampling of BRT Projects

High-capacity transit services in corridors with traffic volumes like those found with the Brisbane, Vancouver, and Ottawa BRT operations have historically been pursued in the United States as light rail corridors. BRT projects on exclusive rights-of-way in the Miami and Pittsburgh BRT programs are substantially influenced by the availability of abandoned freight rail lines and, at least in the case of Pittsburgh, the distinctive topography of the service area. Fully-developed stations that provide off-vehicle revenue collection opportunities and passenger flow control are a characteristic of these projects. Effectively using the resources available, distinct service types have been created that offer higher-quality “rail-like” service in a bus environment.

For many—if not most—areas aspiring to provide “rail-like” service, exclusive rights-of-way are hard to come by. The task in these cases is to provide a pseudo-rail operation in mixed traffic and to support that operation with accoutrements common to premium travel options.

For example, Los Angeles County MTA’s Metro Rapid BRT service currently incorporates these BRT elements: simple route layout, frequent service, level boarding and alighting, color-coded buses, and stations. Metro Rapid does not use articulated buses or exclusive bus lanes, and yet MTA is able to significantly improve the efficiency and effectiveness in the operation as compared to parallel conventional service (Los Angeles Metropolitan Transportation Authority 2001). In a conscious effort to distinguish the BRT mode from basic bus service, BRT stops are physically separated from local bus stops.

Interestingly, the advertising slogan chosen for Los Angeles’ Metro Rapid operation is “New, faster service—same fare!” Efforts have been made in public outreach sessions to emphasize that BRT in mixed traffic is the wave of the future for basic bus service. Positioning the Rapid” operation in this manner logically precludes charging a fare premium, and no fare premium is currently being considered. Additional alternatives at various corridors and facilities are being developed by the MTA and the Los Angeles Department of Transportation (LADOT), significantly extending the reach and improving the

effectiveness of the Rapid™ service. Plans calling for future median operation in exclusive rights-of-way are in abeyance, given the success of operating improvements with bus signal priority.

MTA's Rapid concept presentation has been given a great deal of attention, with various design features displayed prominently in the branding of the service. In addition to the extensive marketing materials produced for the Rapid bus operations, the MTA corporate website presents the service on the same footing as their rail operations. MTA has used bus priority technology to minimize bus bunching and increase average operating speed. Published schedules identifying scheduled time points were eliminated and service information instead focuses on the period between bus appearances, avoiding apparent guarantees of travel time for trips.

In Ottawa, Ontario, a 19-mile transitway was implemented in stages from 1978 to 1996. This bus-only road leads to the CBD, where it connects to exclusive bus lanes on city streets. Over 75 percent of passenger bus trips are made using the transitway. The transitway was constructed largely on rail rights-of-way and was designed for possible future conversion to rail. The main transitway routes use articulated buses with proof-of-payment fare collection to speed boarding; approximately one quarter of the riders pay cash. Feeder buses operate on a timed-transfer system (Federal Transit Administration website: <http://www.fta.dot.gov/brt/projects/ottawa.html>, March 9, 2002).

In Pittsburgh, the 5-mile long West Busway was constructed in an abandoned rail right-of-way that connects rapidly growing communities in the corridor between the City of Pittsburgh and Pittsburgh International Airport. The facility varies in width from two to four lanes, providing a sufficiently wide cross section to allow express buses to pass vehicles stopped at any of the busway's six stations. Fourteen bus routes use the busway; the BRT system was designed so that additional routes could be added in the future (Federal Transit Administration website: <http://www.fta.dot.gov/brt/projects/pittsburgh.html>, March 9, 2002).

The project also includes the Wabash HOV Facility. This 1.1-mile, reversible single-lane facility includes a tunnel through Mt. Washington, using the existing Smithfield Street Bridge to access downtown Pittsburgh. Because

buses are able to pass other buses stopped at stations, two types of bus operations are permitted. The 100 West Busway all-stops route, similar to light rail operation, travels the length of the busway. It stops at all stations, and leaves the busway in the downtown area to provide CBD circulation. This route continues through the downtown and travels to Oakland, an educational, medical, and museum center (Federal Transit Administration website: <http://www.fta.dot.gov/brt/projects/pittsburgh.html>, March 9, 2002). Express commuter routes, the second type of service, enter the busway at one of a number of ramps located along the length of the facility and proceed nonstop to downtown Pittsburgh. The busway is projected to create opportunities for transit-oriented private land development at stations or other transportation hubs in the service area.

The West Busway brings the number of miles of exclusive busways operated by the Port Authority to 16.1. The 4.3-mile South Busway opened on December 18, 1977, and the 6.8-mile Martin Luther King, Jr. East Busway opened on February 21, 1983. The East Busway now carries approximately 30,000 riders on an average weekday, making it the Port Authority's most heavily used fixed-guideway facility. The West Busway carries approximately 7,000 customers per day, with ridership expected to grow upon completion of all proposed park-and-ride lots (Federal Transit Administration website: <http://www.fta.dot.gov/brt/projects/pittsburgh.html>, March 9, 2002).

Conclusions

Reviewing bus and rail rapid transit attributes provides an opportunity to explore the continuum available in terms of technology and its application. With regard to BRT, it need not—and should not—be perceived as a low-cost alternative to LRT. Rather, the services offered by the transit industry should be a reflection of the travel desires of the public and the financial capacity to sustain operation. Adopting a context-sensitive design approach for transit investments is more meaningful with BRT in the short list of options.

In application, BRT elements vary considerably between projects. Therefore, BRT as a mode of transportation includes many variations. By definition, it is truly “omnibus.” Form follows function; whether “bus” or “rail,”

it is essential that the investments made in the name of “rapid transit” deliver real improvements to the traveling public in terms of speed, reliability, comfort, and safety.

References

Ben-Akiva, Moshe, and Takayuki Morikawa, *Ridership Attraction of Rail Compared with Bus*. Report prepared for Urban Mass Transportation Administration, U.S. Department of Transportation. Massachusetts Institute of Technology, 1991.

Biehler, Allen D. 1989. *Exclusive Busways Versus Light Rail Transit: A Comparison of New Fixed-Guideway Systems*. Report prepared for Transportation Research Board.

Buckley, S. M., and A. M. Miller. 2000. *Institutional aspects of Bus Rapid Transit—A macroscopic examination*. California PATH Program, Institute of Transportation Studies, University of California, Berkeley.

California Public Utilities Commission, Transportation Division, Traffic Engineering Section. 1957. *Report on Bus Rapid Transit between Concord and Oakland-San Francisco*. San Francisco, CA: California Public Utilities Commission.

Crain, J. L. 1963. *The rapid transit bus concept*. Paper. Menlo Park, CA: Stanford Research Institute.

Federal Transit Administration. 1994. *The bus transit system: Its underutilized potential*. Washington, DC: U.S. Department of Transportation, Federal Transit Administration.

Federal Transit Administration 1998. *Bus Rapid Transit Demonstration Program*. Washington, DC: United States Department of Transportation, Federal Transit Administration.

Federal Transit Administration. 1998. *Issues in Bus Rapid Transit*. Washington, DC: U.S. Department of Transportation, Federal Transit Administration.

Federal Transit Administration, website: <http://brt.volpe.dot.gov/issues/pt1.html>, April 16, 2001.

Federal Transit Administration website: <http://www.fta.dot.gov.html>. March 9, 2002.

Federal Transit Administration website: <http://www.fta.dot.gov/brt/projects/ottawa.html>, March 9, 2002.

Federal Transit Administration website: <http://www.fta.dot.gov/brt/projects/pittsburgh.html>, March 9, 2002.

General Accounting Office. 2001. Report to Congressional Requesters: *Mass Transit—Bus Rapid Transit Shows Promise*. Washington, DC: U.S. General Accounting Office.

Levine, L. 2000. *Bus Rapid Transit Duels with Rail*. Metro, pp. 43-44.

Los Angeles Metropolitan Transportation Authority. 2001. *Los Angeles Metro rapid demonstration program final report*. Los Angeles: Los Angeles Metropolitan Transportation Authority.

Mitretek Systems. April 2001. *Bus Rapid Transit Vehicle Characteristics* (Draft). Washington, DC: Federal Transit Administration.

Pushkarev, B. S., and J. M. Zupan. 1977. *Public Transportation and Land Use Policy*. Canada: Indiana University Press.

Schiemek, P. April 16, 2001. *Bus Rapid Transit: Reference Guide*. Federal Transit Administration website. <http://brt.volpe.dot.gov/guide/index.html>.

Transportation Research Board. 2000. *Bus Rapid Transit: Why more communities are choosing Bus Rapid Transit*.

U.S. Department of Transportation. 1989. *Urban rail transit projects: Forecast versus actual ridership and costs*. Cambridge, MA: Transportation Systems Center.

Vuchic, V. R. 1999. *Transportation for Livable Cities*. New Brunswick: Center for Urban Policy Research.

About the Authors

JAMES T. JARZAB (commuterassociates@yahoo.com) is president and principal of Commuter Associates. Currently BRT program manager for the Santa Clara Valley Transportation Authority (VTA), his 30 years of professional experience is divided between transit and regional planning. Prior to entering private practice, Mr. Jarzab managed strategic and policy planning for Pace, the suburban bus division of Chicago's Regional Transportation Authority. In serving this position, his responsibilities included long-range

planning, transportation demand management, market research, and transit-oriented development. Mr. Jarzab attended Bradley and Illinois State Universities receiving, respectively, B.S. and M.S. degrees in economics.

JAMES LIGHTBODY (lightbody@vta.org) is deputy director of transit planning and development for VTA. His responsibilities include management of transit studies associated with the development of new transportation services and facilities, planning for transit-oriented development, and the direction of the authority's capital grants and financial planning efforts. He has been with VTA for more than 30 years, with management positions in transportation planning and transit operations. Mr. Lightbody received engineering degrees from Santa Clara and Stanford Universities.

EUGENE S. MAEDA (eugene.maeda@vta.org) is a transportation planner with VTA. He has nearly 10 years of professional experience and is currently working on the Downtown/East Valley major investment study. Prior to joining VTA, Mr. Maeda worked in the express freight transportation industry with ground operations and operations management. He is currently pursuing an M.S. in urban and regional planning at San Jose State University and holds a B.S. degree in transportation management from San Francisco State University.

Bus Rapid Transit: A Viable Alternative?

*Steven E. Polzin and Michael R. Baltes
Center for Urban Transportation Research
National Bus Rapid Transit Institute
University of South Florida*

Abstract

Bus Rapid Transit (BRT) presents a significant opportunity for the public transit industry to enhance the set of transportation investment options that can be brought to bear on the mobility problems experienced by urban areas across the country. As new Census data are released, the picture of strong population growth in dispersed patterns, growing congestion levels, and stubbornly modest transit use levels emerges. This paints a compelling picture that merits serious consideration by transportation planners with regard to the full range of transportation investment options available for urban areas.

This article addresses several specific characteristics of BRT that differentiate it from other public transit modes and supports the explicit consideration of BRT as an alternative in Major Investment Studies (MIS). Clearly, the high cost of rail transit limits the possible role it can play in urban mobility even under radical changes in modal spending priorities. The pursuit of more moderate costing infrastructure transit options increases the chances of public transit being able to make more meaningful contributions to urban mobility. A key characteristic of BRT is the prospect that it can offer a lower-cost method of providing better performing public transit service (not yet fully verified) that is able to both retain current and attract new customers as well as garner political and taxpayer support. Evidence provided by the Government

Accounting Office (GAO) in its recent report on BRT indicated that the BRT projects reviewed cost less to build than the light rail transit (LRT) projects reviewed, on a per-mile basis. In addition, the GAO also points out that ridership was comparable between the BRT and LRT systems reviewed and that five of the six BRT projects had higher overall system operating speeds than the LRT projects.

This article also addresses the definition of BRT and the implications of the various definitions on branding of the mode. An interesting perspective on the BRT branding is offered by looking at it from the perspective of various user groups. In addition, the article explores the prospects of BRT becoming attractive to the public transit industry and with customers, decision-makers, and taxpayers. It continues by addressing certain aspects of BRT that differentiate it from LRT and the comparative impacts on land use by BRT and LRT. The article concludes by offering thoughts regarding the opportunities presented by BRT concept.

Introduction

BRT presents a significant opportunity for the public transit industry to enhance the set of transportation investment options that can be brought to bear on the mobility problems experienced by urban areas across the country. As new Census data are released, the picture of strong population growth in dispersed patterns, growing congestion levels, and stubbornly modest transit use levels emerges. This paints a compelling picture that merits serious consideration by transportation planners with regard to the full range of transportation investment options available for urban areas. Public transit has gained mode share during the past few years and is receiving serious funding commitments from numerous urban areas that program as much as 50 percent or more of transportation resources in support of public transportation as part of long-range transportation financial plans. Yet, the public transit industry continues to struggle to find adequate resources to offer the kinds of services that current and potential riders find attractive.

The ability to implement enough service to meet the expectations for public transportation of even the most pragmatic planners is constrained by the high cost of providing appealing services. Various calculations suggest that the backlog of urban areas proposing light rail systems and rail system expansion is

equal to several decades' worth of funding at current federal program spending levels. In the extreme, if one took the current federal trust fund highway capital spending levels of approximately \$33 billion annually and assumed approximately half was available for capital spending (historically, half has gone for maintenance, administration, enforcement, and research) and assumed that half of that was redirected to guideway transit in urban areas (leaving a modest remainder for nonurban area roadway needs), one would have, roughly, an additional \$8 billion available annually to build new rail transit projects. At average costs of approximately \$50 million per mile, 160 miles of rail systems could be built annually. If that pace were sustained, in approximately 100 years, U.S. urban rail system mileage would equal today's urban interstate mileage.¹ (The cost of operations, maintenance, and replacement is ignored in this hypothetical scenario.)

Clearly, the high cost of rail transit limits the possible role it can play in urban mobility even under radical changes in modal spending priorities. Thus, the pursuit of more moderate infrastructure cost transit options increases the chances of transit being able to make more meaningful contributions to our urban mobility. A key characteristic of BRT is the prospect (not yet fully verified) that it can provide a lower-cost method of providing better performing public transit service that is both able to retain current and attract new customers as well as garner political and taxpayer support. Evidence provided by the GAO in its recent report on BRT indicated that the BRT projects reviewed cost less to build than the LRT projects reviewed, on a per-mile basis (U.S. GAO 2001). In addition, the GAO also points out that ridership was comparable between the BRT and LRT systems reviewed and compared and that five of the six BRT projects had higher overall system operating speeds than the LRT projects (U.S. GAO 2001).

This article addresses several specific characteristics of BRT that differentiate it from other public transit modes and supports the explicit consideration of BRT as an alternative in MIS. This article addresses the definition of BRT and the implications of the various definitions. It explores the prospects of BRT becoming attractive to the public transit industry and with customers, decision-makers, and the taxpaying public. The article also addresses aspects of BRT that

differentiate it from LRT. In addition it addresses the comparative impacts on land use of BRT compared to LRT. The article offers some concluding remarks regarding the opportunities presented by BRT.

Defining BRT and Establishing the BRT Brand/Concept

Early attempts at defining BRT have offered several definitions of exactly what BRT is and Vuchic (2002) has even challenged the “rapid” nomenclature in the name BRT. It is inevitable that there will be discussions of the exact meaning of BRT, and it is likely to be an evolutionary concept just as transportation planners spent several years and hundreds of hours discussing with colleagues the definitions of such terms as intermodal, sustainable, and Intelligent Transportation Systems (ITS). One consideration that will ultimately influence the image and acceptance of BRT is the breadth of application of the BRT designation. One question that will need to be answered is how different and distinct from standard local bus service does BRT have to be to be designated “Bus Rapid Transit.” As there are more applications of any public transit mode, there are greater opportunities to refine the mode to accommodate specific local conditions and the modal definition evolves with the integration of evolving technologies such as new propulsion systems, vehicle design changes (e.g., low floors), and other factors that impact fare collection and customer information and other amenities. As this occurs, the historic technology-based definitions of modes become less precise and the variations in traits become wider. Just as we increasingly see huge variations in fundamental traits ranging from capacity to costs to operating speeds for LRT projects, so too is the prospect for huge variation in what is branded as BRT, ultimately contributing to wide variations in capital and operating costs, ridership, performance, and other crucial considerations. The extent to which there is variation in these traits may influence the extent to which BRT can establish a niche identity within the modal arena with current and future customers as well as decision-makers.

Historically defined by technological characteristics, modal definitions have become increasingly complex as evidenced by the rather elaborate classification and trait enumeration developed by Vuchic (1981) and several others. The

argument could be made for a narrow and comprehensive set of traits as the basis for defining BRT. Or, perhaps, it could be argued that even modest initiatives are a step in the right direction in defining BRT (especially if specific BRT branding offers marketing benefits). Auto manufacturers change styles and vehicle names every few years for essentially the same product. So, perhaps public transit should similarly leverage any advantage the BRT branding can create. It could be argued that BRT is an attempt to inject new energy into traditional bus services and that incremental or piecemeal implementation of various features categorized as aspects of BRT to improve individual bus services is for the good of all concerned. It might even be argued that the use of the BRT designation can enhance the overall image of bus-based public transit and looser definitions will make it affordable to implement BRT features for many parts of a transit system. This, in turn, should spread the benefits over the larger community and diminish equity and political allocation issues that accompany more expensive programs that could only be implemented in a much narrower application.

Some have argued that the “B” in BRT has to go and that part of the branding should distance the mode from bus by referring instead to Commuter Rapid Transit or variants on that terminology to create a whole new image for consumers divorced from the image of “bus.” A narrower definition and classification structure could be used to support the unique image of BRT in contrast to standard local bus transit. Arguably, the unique definition can build customer support and decision-maker endorsement thereby positioning BRT proposals to gain sufficient favor to aid in securing funding and use by prospective passengers. Furthermore, the higher standard of classification may be perceived as significant and positive to the transportation professionals in planning and land development. A higher standard of definition creates a greater opportunity to leave a unique, positive image for BRT and further differentiate it from standard local bus services.

To the extent that there may be differential eligibility for funding for BRT versus standard local bus service, the BRT definition used would influence the number and nature of the projects seeking the designated funding and make the issue of the definition of BRT far more significant.

Who Cares What Better Public Transit Service Is Called?

An interesting perspective on the BRT branding is offered if one looks at it from the perspective of various user groups. Existing customers of standard local bus services that might alter their mode of travel would no doubt be indifferent to the nomenclature used. These customers often have no alternatives to public transit, no matter how low or high the quality or how low or high the cost of providing the service. They are obviously not avoiding the service today due to any stigma, so any substantive service or image improvements are positive regardless of what the new service is called. Admittedly, the image of public transit can impact current users and nonusers may be more likely to use improved public transit service if it was branded in a way that had a more positive image. However, the substantive improvements in performance (speed, reliability, comfort, etc.) are likely to be as or more influential in the decision to use the service or not. Just as rail transit planning and forecasting professionals have spent a great deal of resources researching and debating the presence of a modal bias factor in rail ridership, so too, there may be ridership impacts based on how we define and position the image of BRT (Ben-Akiva 1991). The GAO's (2001) recent report on the promise of BRT as a viable alternative to rail indicates that one of its disadvantages is that buses have a poor public image. The unique features of BRT such as improved vehicles and higher operating speeds can be used as part of the BRT branding to leverage the amelioration of the negative perception of bus-based public transit. Further, according to Camph (1997), while local government officials have been eager to spend more money on transit, voters, when given a choice, are turning down transit initiatives a significant share of the time.

The definition of BRT may also be relevant to funding partners and the development community. The nomenclature may impact on the general public, whose image of public transit service may be affected, influencing the willingness of the public to support funding for public transit. Will a community be more willing to pass a referendum to support bus service expansion versus BRT implementation versus LRT investments? If BRT is perceived as a substantive and significant improvement in service, will it be more positively

received and supported than if it is perceived as a cosmetic makeover of an existing service? It can be speculated that the narrower definitions of BRT that refer to a higher quality of service might have the greatest influence in terms of financial support from the public and decision-makers.

The Role of BRT in the Great Bus versus Rail Debates

The real dead end is BRT, we've been trying BRT in one form or another in this country for eighty years and it's been a miserable failure. Transit ridership has fallen when all bus systems have been adopted and rose when rail systems implemented. I seriously doubt BRT will be used on a large scale in this country. Unless of course the bus manufacturers spread big bucks around to get it adopted.

The big selling point of BRT is that anything compared to light rail looks like a bargain and effective transportation solution. As long as the question remains "how can we provide the cheapest most effective public transit" the answer will be BRT. The problem for agencies however is the dysfunctional accounting standards of the FTA. BRT operating expenses are calculated as being higher than LRT under the current weird rules. As long as "somebody else" is paying for the infrastructure the agency will still prefer LRT.²

The two above quotes taken from a listserv that regularly debates the merits of various public transit proposals epitomize some of the passionate positions that have regularly surrounded discussions of bus and rail service. This debate has become a major issue as various urban areas contemplate rail investments and propose local referendums to provide the necessary capital and operating funds. Developing strategies for responding to criticisms of rail critics have resulted in numerous initiatives within the public transit industry such as Railvolution (an annual national conference espousing the virtues of rail development and associated land-use initiatives) and a series of American Public Transit Association (APTA) sponsored publications authored by noted conservatives such as Weyrich and Lind (1996, 1999, 2001). These publications

advocate the virtues of rail from a conservative perspective. These passionate debates embrace issues of smart growth, personal freedoms, environmental impacts, and technical performance. BRT appears to be embraced by historic critics of rail investments but, inevitably, will be embroiled in the debate about what transportation investments are best for our urban areas. As evidenced by the discussion, perhaps inaccurate perceptions, historic prejudices, and modal biases will inevitably influence the public's perception of BRT. Ultimately, the definition of BRT and its acceptance will be significantly influenced by BRT's ability to influence development patterns and land use. This issue is discussed in the BRT land-use section of this article.

Enriching the Choice Set for Urban Transportation Investments

Often alternative mode investments are supported partially because they offer a "choice" or "option" for travelers. Indeed, many advocates of various modes argue that they should be provided to offer travelers several choices. The virtue of offering choices has at least two elements of value. First, consumers value choice in various products from housing to breakfast cereal to footwear. Manufacturers certainly offer choice in vehicle styles with dozens of variations, from economy compacts to luxurious sport utility vehicles. The value of this choice to consumers is acknowledged in economic theory and this logic has been extended to explain the value of offering modal choices as well by Chu and Polzin (1999). Choice also has contingency value or value in the context of unexpected events. Public transit has evidenced its value in this manner in a number of situations from providing travel options when much of the roadway is shut down due to inclement weather to being available when earthquakes, hurricanes, energy shortfalls, or acts of terror cripple other parts of the transportation system. Since September 11, 2001, there has been increased sensitivity to the value that alternative modes might provide in cases of acts of terror.

While BRT or other new transit options for an area may provide value in these situations, a perhaps equally relevant benefit is the value that it provides by offering decision-makers a far greater set of investment and service options from which to choose. A historic dilemma of the MIS process, and before it the

Alternatives Analysis process, is the fact that the range of choices explored in these studies is typically quite limited and has major discontinuities in the range of key evaluation traits. The BRT alternative may offer an option where its performance is significantly different than for other build alternatives. The cost, time frame for implementation, geographic coverage, and ridership can each be significantly different than for other alternatives under consideration. By virtue of providing an alternative with distinctly different traits than the base or Transportation Systems Management (TSM) alternative and the Build Rail alternatives, it offers value to decision-makers by enhancing the range of options they have in addressing an area's needs. Typically, BRT options will "fill the gap" in a significant range of cost differences between TSM and LRT options.

In corridor studies with no BRT options, decision-makers are faced with a situation where the cost variations between the no-build and build options are very large, with the capital cost of rail-build options often orders of magnitude larger than the capital cost of the TSM option. Perhaps an even more relevant consideration to local decision-makers, the choice set is one between a project that qualifies for federal new start funding or one that is dependent on local and formula funding. Thus, decision-makers are often faced with an all or nothing choice as it relates to federal new start funds. A BRT option offers not only a chance to provide a richer range of choices with options that have various costs and impacts, but it offers another choice or choices that are eligible for federal funding. This is a very significant consideration as local areas weigh various investment options. In general, a richer set of choices with variations in values along critical evaluation criteria values will provide decision-makers with an opportunity to more closely match a solution with their particular value sets as mapped against the various impact measures.

Figure 1 shows select data from an MIS conducted in 2001 that considered six alternatives including a no-build option. BRT was not considered as an alternative during the MIS process. As is apparent from the figure, the variation between the bus and rail-build options resulted in an area of cost and ridership ranges for which the decision-makers had no options. The prospect that BRT options might have been able to be prescribed such that they would

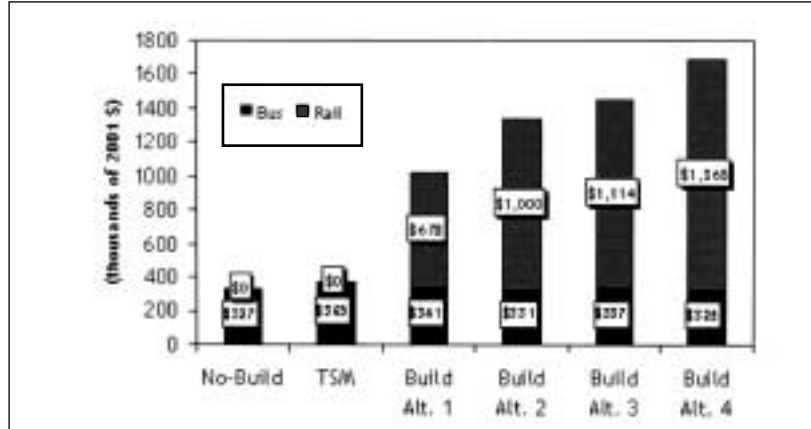

Source: www.tamparail.com.

Figure 1. Tampa rail project capital costs (in year 2001\$)

have offered investment opportunities that provided a richer range of choices offers value to decision-makers. An analogy might be a consumer shopping for a new car having to select between a low-cost economy car and a high-priced luxury car with no other choices (would you like a Ford Pinto or a Mercedes sedan?). Decision-makers are more likely to find alternative options that are appealing within a set of investment options that gives them a richer range of choices.

BRT Versus Rail or BRT Versus Nothing?

A second issue impacting the consideration of BRT is the nature of the choices being made. As the introductory paragraphs of this article suggest, some of the motivation for considering BRT is the prospect that one cannot afford the “true preference” of a rail alternative. Indeed, in many cases, the BRT option may be a direct competitor with a rail alternative, and affordability as well as or regardless of cost effectiveness and other factors will be important in the decision.

In some contexts, BRT is perceived to be a default alternative to implementing a rail system, indeed, a second-class alternative compared to the light rail alternative. As is readily acknowledged by many transportation planners,

MISs are occasionally situations where the public will or at least the political will is well known and the process is more a case of refining expectations and design and then complying with requirements than a sincere search for alternatives that address a given transportation problem. In situations where that is the case, the BRT option is a threat to pursuit of “the preferred option.” To the extent that BRT compares favorably with the other alternatives, some parties with predetermined preferences may be reluctant to see the consideration of BRT options as standard options in most MISs. To the extent that BRT risks making it more difficult to select another alternative because its performance based on evaluation criteria is relatively attractive, the advocates of other options would be motivated to not include or perhaps discredit the BRT option. These contexts are likely to perpetuate the “bus” versus “rail” tension and push the focus to the intangibles. Thus, factors such as public acceptance, impact on land use, status and image considerations, and the old reliable “but choice riders just aren’t willing to ride the bus” arguments are likely to surface. The modest empirical data on BRT impacts in U.S. operation will, at least initially, enable these arguments to persist.

However, the choice is seldom between an LRT and a BRT option for a given corridor. In some cases the trade-offs will be between BRT and traditional baseline or what used to be known as the “do nothing alternative.” BRT may be an attractive option in some situations where LRT is clearly not in the set of choices. Thus, in these situations, none of the comparative relationships between BRT and LRT comes into play in the choice. In other situations, the choice might more realistically be characterized as between LRT in part of one corridor and BRT in more of the corridor or even in multiple corridors. The comparative cost of BRT may be such that the urban area may actually be trading off the financial ability to provide LRT in one corridor while they might be able to provide BRT in two or more corridors at a lesser or similar total cost. Thus, while a given corridor-level MIS may imply that the choice is between two modes for a given geographic need, the more accurate reflection of the longer-term systems-level choice may be to characterize the BRT option as enabling the area to trade off unit cost versus overall system coverage.

Numerous communities are operating under the assumption that the federal government will pay half of the cost of a rail system and that their state may pay another share. This expectation, absent a realistic understanding of the probability of receiving federal funds or the probable time frame for receiving federal funds, makes it very difficult for decision-makers to show the same sensitivity to affordability as would be the case if their projects were funded with formula or local dollars. Thus, as the prospect that the federal share of rail projects declines as directed by the Fiscal Year (FY) 2000 Consolidated Appropriations Act (P.L. 106-113) there is a greater chance that the affordability issue will become more important in urban transit investment decisions.

BRT and Equity

Over the past several years there have been repeated challenges to rail investment programs based on concerns over equity. These challenges have been both concerns about equity between various parts of the urban area and equity between investment in rail versus sustaining or enhancing existing bus services. BRT, by virtue of it being lower-cost than rail and perhaps having a lower standard of justification than rail, will inevitably create additional challenges regarding equity of investment allocation. The more modest the cost and performance impact of a BRT investment the stronger the challenge to provide BRT enhancements for a broader range of locations within the community. Thus, it is inevitable that there will be pressure to define standards of performance for proposed BRT projects to have a basis for justifying locations where BRT is a prudent investment. As the profession moves closer to a standard definition of BRT, it may well be prudent to establish expectations of BRT performance improvements that provide a rational basis for justifying the geographic allocation of BRT services. Title IV has long required the equitable allocation of bus equipment and necessitated a conditions-based justification for differential allocation of equipment. So too the establishment of BRT services will require a rational basis for the allocation of these services across urban areas. As more areas consider BRT, there will be more need to refine the processes by which BRT planning and decision making are carried out if it is not part of a major investment study process.

Flexibility Over Time

One of the oft-cited virtues of rail investment is the physical presence and permanence of the infrastructure investment that accompanies its construction. Indeed, this physical presence does have an advantage of enhancing customer awareness, and the permanence does signal to the development community a commitment to public transit service in a given area. BRT options do need to acknowledge these issues and offer logical responses to these traits of rail investment. First, the issue of physical presence can be quite readily responded to by BRT proposals because most BRT initiatives have identifiable traits intended to make them unique. Thus, customers, adjacent residents and businesses, and the general public traveling past a BRT alignment should be able to identify its physical presence. A host of features from exclusive rights-of-way to signage, stations, electrification, or other features can establish the presence of a BRT project. Indeed the physical presence of some subway systems is extremely modest and can clearly be matched by modest BRT infrastructure investments.

The issue of permanence can also be addressed by BRT. First, permanence is not always a virtue. Indeed, dark, narrow rail platforms, 5-mile-per-hour elevated curves, restrictive platform widths and lengths, and the massive investment in fixed infrastructure for propulsion systems, station access, and structures often precludes rail systems from adapting the most attractive and efficient current technologies or designs. A rail car investment with a 40-year life, in effect, locks the system into a specific design for 40 years. New materials, propulsion systems, safety features, and other modernizations are often precluded by the constraints of the initial infrastructure's fundamental design and financial realities. BRT systems, on the other hand, are afforded the opportunity to have vehicle technology amortized over shorter time periods more typical of the 12-year average life of a standard coach. Thus, changes in amenities, safety, accessibility, propulsion system efficiency and cleanliness, and other features can be updated on a more meaningful and more frequent basis. The lack of permanence can indeed be a virtue, offering the opportunity for regular modernization.

The other aspect of permanence deals with the prospect that the service will remain in its current location. Presumably, a more major investment symbolizes a greater likelihood that the investor will be less likely to walk away from the investment. Perhaps the most relevant context would be the abandonment of the streetcar systems in U.S. cities in the decades following World War II. With the exception of that era, there have been few meaningful abandonments of guideway service. It might be presumed that BRT, being less capital intensive, would more likely be abandoned if the market were not supporting the service. While such a situation is possible, the level of planning and the market conditions that would support BRT investment are such that there should be very little prospect that the service would be abandoned. In fact, one of the criticisms of bus service in many U.S. cities is that the buses still operate on the same route they did a century ago and have not adapted to evolving travel patterns. The practical reality is that BRT investments in markets that are strong or forecast to be strong are highly unlikely to see dramatic declines in public transit service. BRT represents a significant investment with a probable amortization time frame for all assets of greater than 20 years. The existing infrastructure that justifies these investments, in all probability, has an economic life far greater than 20 years. This same infrastructure also supplies the travel demand that enables BRT investments to be justified and rationalized. The greater risk is that land-use changes cause transit ridership declines rendering the BRT investment less productive, rather than the BRT investment abandons a healthy or vigorous activity corridor.

Is BRT a Step Toward LRT?

Some planners and policy decision-makers envision BRT as an incremental investment that may be a precursor to the eventual implementation of rail. The logic of this argument is that the BRT investment will test and develop the market and when the market matures it will be appropriate to implement rail options. This logic, similar to that of many incremental investment advocates, has the virtue of minimizing risks if the market never develops. Higher capacity and higher-cost investments are not implemented and it potentially matches the investment level more closely with the benefit stream attributable to a project.

The major criticisms of this strategy fall into two types. First, there is the issue of whether incremental implementation is physically or financially possible. To the extent that the interim technology uses the same right-of-way, the prospect that the initial service can be shut down or worked around while a future higher-class facility is implemented is often very tenuous. Perhaps, more critical, the motivation for subsequent implementation of a rail investment is likely to be difficult to establish.

BRT should enable incremental upgrades and it is highly improbable that a corridor that had a BRT project is also likely to be in line for rail investment within the near term. It may be difficult to come back to the same corridor a second time with major investment dollars as other geographic areas argue that it is their turn to receive investments. Advocates of rail would have two possible fears of proposals for incremental implementation with an initial BRT project. First, if the BRT were not deemed successful, transit critics might argue that it was a good thing that rail was not implemented since the BRT project was not successful, the logic being that if the corridor would not support BRT it certainly would not be able to support rail investments. Rail advocates might counter that disappointing performance of BRT is not necessarily indicative of how a rail investment would have performed, as rail might have been better able to attract ridership and development. This fear of success is similar to that of those persons who do not feel that the lack of success of traditional intercity rail is necessarily a harbinger of the success of high-speed rail.

Alternatively, a successful BRT might suggest to some that rail was not necessary. The successes of BRT would be used as evidence that the benefits could be captured at a lower cost with BRT. Thus, those with a passionate advocacy of rail for a given corridor may be reluctant to see BRT proposed as an alternative even if it is envisioned as only an interim solution. Their fear would be that BRT would be successful and rail might never be implemented if there were a successful BRT. In the case of BRT, the specific nature of the proposed BRT and its capabilities and performance may be critical in determining how well its success is a harbinger of how rail might do in the corridor.

BRT and Land Use Versus LRT and Land Use

Perhaps the most critical consideration in evaluating BRT proposals in comparison to LRT proposals will be the perceptions as to the ability of the respective alternatives to meaningfully influence land use. This issue will be discussed in the context of a framework for understanding the impacts of public transit investments on land use detailed in Polzin's "The Transportation-Land Use Relationship: Public Transit's Impact on Land Use" (1999).

Figure 2 outlines a series of factors that are hypothesized to underlie the impact that transit investments can have on land use. This representation of transportation's impact suggests that there are three ways that transportation investment can influence land use:

1. by providing transportation accessibility,
2. by encouraging complementary investment policies, and
3. by creating momentum or expectations that influence land use.

Current theory and land-use modeling focus almost exclusively on trying to define this first relationship, how transportation accessibility improvements impact development. The second and third elements are hypothesized as perhaps more significant in the overall relationship, particularly as it relates to public transportation. Indeed, the impact of an LRT project on an urban area may arguably be far more significantly influenced by the impact it has on stirring land-use policy and planning activities than through the power of the increased transportation capacity it delivers to station areas. In the context of this more complex model of how transportation impacts land use, the differences between BRT and LRT are not just their differences in transportation performance and capacity, but also the differences in their ability to motivate other planning changes that significantly drive land-use development.

The top section in Figure 2 (labeled "Accessibility Improvements") is the one that receives the most attention by urban and transportation planners. If our urban planning goal set includes influencing land use, then the planner

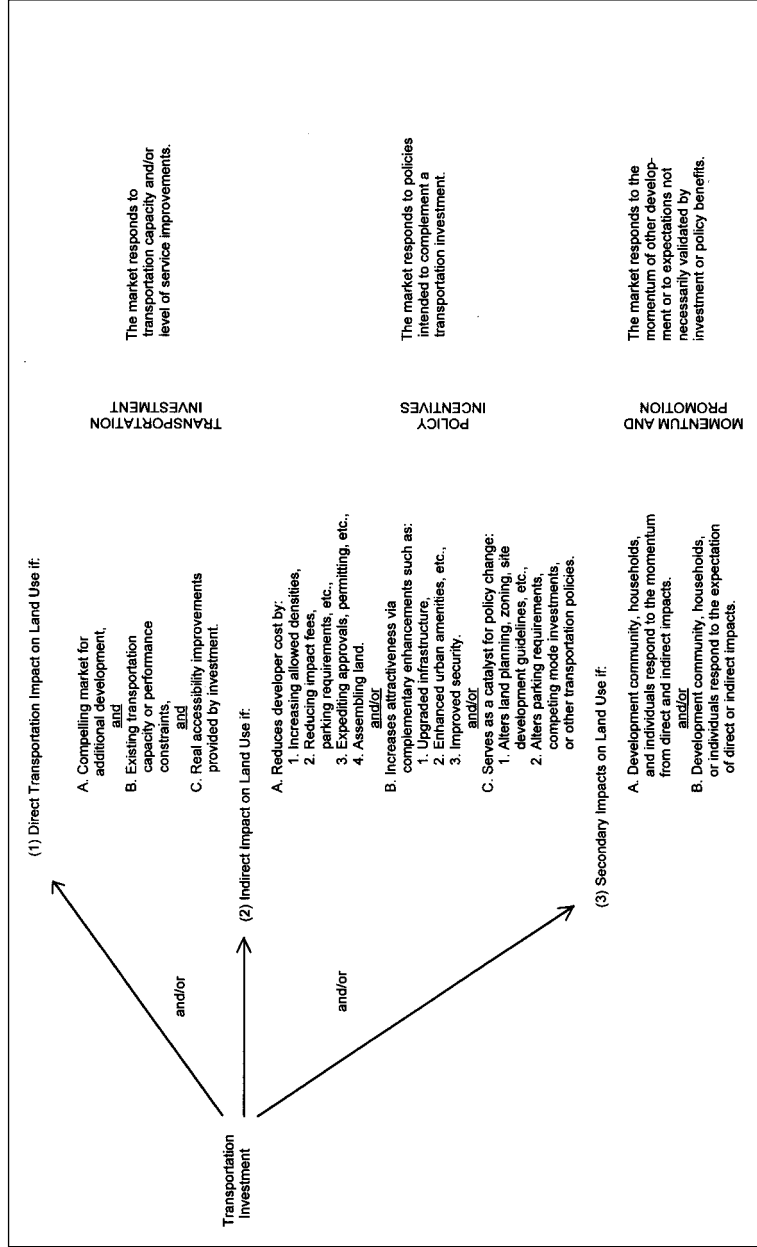

Figure 2. Land use responses to transportation investment

might typically measure the ability of an investment to accomplish this goal based on how the proposed investment changes accessibility. MIS, for example, includes assessments of the changes in accessibility attributable to the new investment. Changes in accessibility are then a major contributor to travel demand and development potential. One might speculate as to whether a given BRT proposal would result in a different change in accessibility than would an LRT investment for the same corridor. Analytically, planners could apply measures that could determine this.

While context-specific data would need to be evaluated, BRT could conceivably have greater frequency and faster door-to-door travel speeds. Alternatively, LRT may have more exclusive right-of-way and provide faster travel time.

Figure 2 reminds the reader that additional accessibility is only of value if there is a demand for additional travel (which is a catalyst for development) and if there is a constraint in existing capacity. Thus, neither transit investment will cause development if the underlying demand is not there. For example, building BRT lanes or LRT lines in rural farmland will not induce high-rise condos to sprout up at transit stops.

The second section in Figure 2 (labeled “Complementary Policies”) indicates the role of transportation planning and investments in motivating complementary policies. Thus, the impact of transportation investment is not only in its direct accessibility impact but, perhaps, as or more importantly, in its ability to spur complementary policy initiatives that subsequently influence land use. A key benefit of rail system planning may be the fact that it can serve as a community focal point to discuss a community’s transportation and land-use vision. The transportation investment provides the impetus, and perhaps the planning funds to support the development of community plans and policies that influence land use. Transit investments, in particular, can be a catalyst for a host of planning, investment, and policy commitments that subsequently influence development. Thus, the transit investment may be leveraged by a community to create a land-use response far greater than might be achieved based solely on the changes in regional accessibility that the transit investment

provides. The nature of the incentives from additional complementary investments or policies is categorized into three groups in Figure 2: cost reductions for development, additional amenities that enhance development, and complementary policies that support development.

The critical issue when contrasting the land-use influencing capabilities of LRT and BRT becomes one of determining the extent that these types of development-inducing actions are exclusive or more significant for LRT than for BRT proposals. Is the extent to which these conditions exist due to the financial magnitude of the project or the physical presence of the project? Or are they due to the perceptions and attitudes of the transportation and planning professionals and decision-makers who are variously motivated to make things happen based on their own values and perceptions?

It is too soon to draw conclusions from empirical evidence as to the resultant ability of BRT versus LRT initiatives to coalesce complementary land-use initiatives. The extent to which BRT is able to create land-use impacts will be significantly dependent on the actions of the profession, funding agencies, and decision-makers toward leveraging the investment in BRT.

The third section in Figure 2 (labeled “Promotion and Momentum”) indicates that the transportation investment can serve as a vehicle for drawing attention to development opportunities near transportation facilities. Momentum and promotion can influence development regardless of the transportation consequences of transportation investments. This category may be less significant than the preceding two categories but, nonetheless, is very relevant in today’s planning and development environment. This category is intended to acknowledge the influence of development momentum, agglomeration economies, and the impacts of promotion associated with development near major transportation investments. Economic theory of development often talks about the economies of agglomeration for development. In simple terms, this means that development is attracted to development. A copy shop or restaurant might logically choose to locate near a new office building. Thus, if enhanced transit accessibility or developer inducements can attract an office building, one may get a print shop, restaurant, day care center, or other complementary development as a result of

the natural market forces at work in the development community. The restaurant may not be motivated to make a location decision based on the transportation investment but rather based on the office development. The development community is very much momentum-driven. To the extent that a trend can be started in development, there is often continuing momentum after the initial motivation for development has been satiated.

Related to this is the “hype” that the planning community creates. Regardless of the empirical data or quantitative accessibility offered, if decision-makers or professional planners tell developers or the public that it is a great idea to locate near rail or BRT stations, some of them will. Perceptions are reality, and with enough attention, at least some expectations regarding the land-use impacts of transit investment can be self-fulfilling prophecies simply by virtue of the fact that this subject is getting a great deal of attention and advocacy by some elements of the planning community. If enough people are told how useful or advantageous it can be to locate near transit, then there is likely to be some land-use impact. Professionals and policy-makers influence perceptions and, in turn, perceptions influence behavior. Thus, the land-use impact of BRT may be meaningfully impacted by the messages that the profession espouses regarding the virtues of development adjacent to BRT. BRT’s ability to influence land use relative to LRT is partially in the hands of the professionals in the transportation planning community. Will BRT be embraced as a tool to influence land use and advocated and leveraged as have LRT investments, or will BRT’s land-use impacts be discounted or diminished irrespective of the accessibility impacts of BRT?

One feature of rail investments that has perhaps contributed to the perception that they influence land use is the fact that they are relatively modest systems in many cities. That is, the number of miles of rail investments is a small fraction of the number of miles of bus routes or the number of miles of roadways of any given type. Thus, rail stations are relatively unique. For many products, limited supply can drive up demand. Thus, if there are limited opportunities to develop near rail stations, then the value of those limited sites may be driven up suggesting a significant land-use influence/impact. On the other

hand, if an urban area were saturated with rail service such that there was very little exclusivity associated with being located near a station, then the land-use impact, as measured in land price changes, might be far more modest. In light of this price elasticity, the prospect that more expensive rail investments are likely to be more modest than BRT investments may mean that proximity to rail is rarer and, hence, of higher value. However, this does not speak to the total impact on land use of BRT versus LRT. One might, in the case of BRT, be able to influence land use in several corridors for the same total cost as influencing land use in one corridor with rail investment. Thus, one must be cautioned as to how land-use impacts are measured and interpreted across modes.

Conclusions

Over the next decade or two, there is an opportunity to have a greater change in the technology and image of bus service than has occurred since the introduction of internal combustion powered buses. Much of this change is cast regardless of the terminology that the industry applies or the classification and categorization strategies that are used to define various modes of public transit. With respect to virtually every parameter of performance relevant to transit customers and the community, these changes signal improvements in public transit services. Aesthetics and amenities that translate into image, pollutants and energy efficiency, service reliability and safety, customer information/communications capabilities, accessibility to passengers and, perhaps, even capital and operating costs can be improved with the careful integration of technology into the provision of bus services. These changes, implemented in varying degrees in all bus service or coordinated into comprehensive packages and positioned as BRT services, provide an opportunity for the transit industry to deliver an improved product to the public. In some cases this will be independent of consideration of rail investments, in some cases in addition to rail investments, and in some cases instead of rail investments. BRT adds an opportunity to showcase improvements in public transit service and, in many instances, enables improvements that would otherwise not be affordable or cost-effective in the context of lower-density transit markets.

The impact of BRT on public transit cannot be preordained but will definitely be impacted by how well the industry delivers on the promise of BRT and also on how well the BRT concept is leveraged to accomplish all that can be accomplished across the full range of goals that communities have for public transit systems. How BRT becomes defined is far less important than how it is effectively integrated into the overall range of transportation solutions planners use to address mobility and related problems.

Endnotes

1. This statement is partially based on data from Highway Statistics 2000, a report of the Federal Highway Administration. This document outlines revenues, spending, and system extent.
2. Extracted from listserv discussion of transit technologies, December 2001.

References

- Ben-Akiva, M., and T. Moriwawa. 1991. *Comparing the ridership attraction of rail and bus*. Unpublished.
- Camph, D. H. 1997. *Dollars and sense: The economic case for public transportation in America*. Washington, DC: Campaign for Efficient Passenger Transportation.
- Chu, X., and S. E. Polzin. 1998. The value of having a public transit travel choice. *Journal of Public Transportation* 2 (1).
- Polzin, S.E. 1999. The transportation–land use relationship: Public transit’s impact on land use. *ASCE Journal of Urban Planning*. (December).
- U.S. General Accounting Office. 2001. *Mass transit: Bus Rapid Transit shows promise*. Washington, DC.
- Vuchic, V. R. 1981. *Urban public transportation systems and technology*. Englewood Cliffs, NJ: Prentice-Hall.
- Vuchic, V. R. 2002. Bus semirapid transit as an option in analysis of alternative transit modes. *Journal of Public Transportation* 5 (2).
- Weyrich, P. M., and W. S. Lind. 1996. *Conservatives and mass transit: Is it time for a new look?* Free Congress Foundation.

Weyrich, P. M., and W. S. Lind. 1999. *Does transit work? A conservative reappraisal*. Free Congress Foundation.

Weyrich, P. M., and W. S. Lind. 2001. *Twelve anti-transit myths: A conservative critique*. Free Congress Foundation.

About the Authors

STEVE POLZIN (polzin@cutr.usf.edu) is director of public transportation research at the Center for Urban Transportation Research at the University of South Florida and is responsible for coordinating the Center's involvement in the University's educational programs. He is involved in a variety of transportation research and teaching activities at the University. Dr. Polzin carries out research in areas such as planning process development and design, mobility analysis, travel behavior, project evaluation, transportation safety, high-speed rail, public transportation, and transportation decision-making.

Before joining the University of South Florida in 1988, Dr. Polzin worked for transit agencies in Chicago, Cleveland, and Dallas. He also currently serves on the Board of Directors for the Hillsborough Area Regional Transit Authority, known as HARTline.

Dr. Polzin received a BSCE from the University of Wisconsin-Madison, and Master's and Ph.D. degrees from Northwestern University. He is active in a number of professional organizations, and is regularly cited and published in the media on mobility and transportation issues.

MICHAEL R. BALTES (baltres@cutr.usf.edu) is a senior research faculty at the National Bus Rapid Transit Institute located at the Center for Urban Transportation Research in Tampa, Florida. He has worked at the Center as faculty for almost 12 years. During his tenure at the Center, he has gained extensive experience in the areas of BRT, transit planning, transportation economics, Intelligent Transportation Systems, and a variety of other research areas. He holds both graduate and undergraduate degrees from the University of South Florida. He is an active member in a number of professional organizations, and is regularly cited and published in the media on BRT and other transportation concerns.

Bus Semirapid Transit Mode Development and Evaluation

*Vukan R. Vuchic
University of Pennsylvania*

Abstract

With little investment required for operating in streets, bus services are often designed to serve many overlapping routes with frequent stops. To upgrade services and attract choice riders, major bus routes should be provided with exclusive lanes, preferential signals, and fewer but more distinct stops.

The Federal Transit Administration's (FTA) Bus Rapid Transit (BRT) program is aimed at upgrading bus services into semirapid transit category (technically, bus semirapid transit). Many similar programs in the past were initially successful but later degraded by allowing sharing of lanes by high-occupancy vehicles (HOV) and relaxed enforcement of traffic control. With the systems approach organized for the BRT program, implementation chances will be greatly enhanced. It is expected that a successful BRT program will have a positive impact on many other bus services. Improved bus services should be seen as a significant step to higher-quality, attractive transit services which will represent major lines in smaller cities or complementary lines with rail transit in larger ones.

Introduction

The vast majority of bus services consist of buses running in mixed traffic on many overlapping lines with different headways. In many cities the obsolete practice of having bus stops on every corner is still used. Bus travel speed is often low, and reliability depends on traffic conditions. With complex line alignments

and confusing networks, buses often can not compete with car travel, so they serve mostly captive riders.

Upgraded bus services, primarily those with separate rights-of-way, represent a very cost-effective method to increase transit usage. Many measures for bus service improvements were introduced since 1970 (Wilbur Smith and Associates 1975; OECD 1977; RATP 1977), but in many cases buses were gradually returned to operations in mixed traffic. The present FTA program promoting BRT (Transportation Research Board 2001; Diaz and Schneck 2000) is a logical step forward in improving not only bus transit but the quality and image of transit services in general. As introduction of new light rail transit (LRT) systems improves transit image in the entire city, introduction of a BRT line should be expected to have a beneficial impact on other bus lines, as well as on intermodal integration between bus and rail transit lines.

The designation BRT is actually a trademark of the federal program. Technically, with partially separated rights-of-way, this mode belongs in the semi-rapid transit category. This article discusses bus semirapid transit (BST) and compares it to neighboring modes: regular bus (RB) and LRT.

Definition and Characteristics of Transit Modes

The selection of transit mode is a critical decision in planning new transit systems. To perform this complex task correctly, it is necessary to precisely define transit modes and their components and to have a thorough knowledge of characteristics and relationships of different modes. Moreover, it is necessary to avoid simplistic evaluations based on a single criterion, such as minimum cost.

Three main characteristics define transit modes: *right-of-way (ROW)*, *technology*, and *type of operations*. Although vehicle technology is most visible and the public tends to recognize the modes as bus, trolleybus, light rail, and metro, the ROW category is actually the most important mode feature. It determines the basic characteristics of modes and strongly influences the selection of system technology, vehicle design, and operational features.

The basic characteristic of ROW is its degree of separation from other traffic. In this respect, three categories of ROW are defined, and they determine generic modes of urban transit.

1. ROW category C represents urban streets with mixed traffic. Transit vehicles, bus or rail, operate in mixed traffic. Modes utilizing ROW category C represent street transit, which requires very low investment (streets already exist) but operates with speed, comfort, and reliability of service that depend on traffic conditions, so that they may be variable.
2. ROW category B is partially separated from other traffic but has crossings at grade. Typically, this ROW is a curbed street median with LRT tracks, which go through intersections and can be crossed by pedestrians. LRT tracks may also go through parks, on railway ROW, etc. Physically separated (curbed) bus roadways also represent category B. Modes with this type of ROW are called “semirapid transit.” They require substantially higher investment than street transit but also provide higher performance.
3. ROW category A is fully controlled and used exclusively by transit vehicles. Representing rapid transit generic class, these transit systems require the highest investment, but they also provide by far the highest performance in terms of speed, reliability, capacity, and safety.

Figure 1 is a diagram of mode performance versus investment costs per kilometer of line for three categories of transit modes, representing, respectively, street, semirapid, and rapid transit. This diagram shows that street transit modes, such as regular bus, involve the lowest investment cost but have the lowest performance. Semirapid and rapid transit require considerably higher investments but provide higher performance.

The entire family of transit modes is listed in Table 1, starting from the basic one, bus operating on streets, to modes which have more advanced features—from ROW category C to B and A, from diesel internal combustion engines (ICE) to electric motors, from steered single vehicles to guided long trains. As these features change, modes have higher performance in terms of speed, reliability, capacity, safety, and image. This sequence shows that the ROW category is the basic element which determines the mode technology and thus influences features of modes and their performance. For example, once ROW category A is selected and major investment has been made, it is logical to fully utilize it by

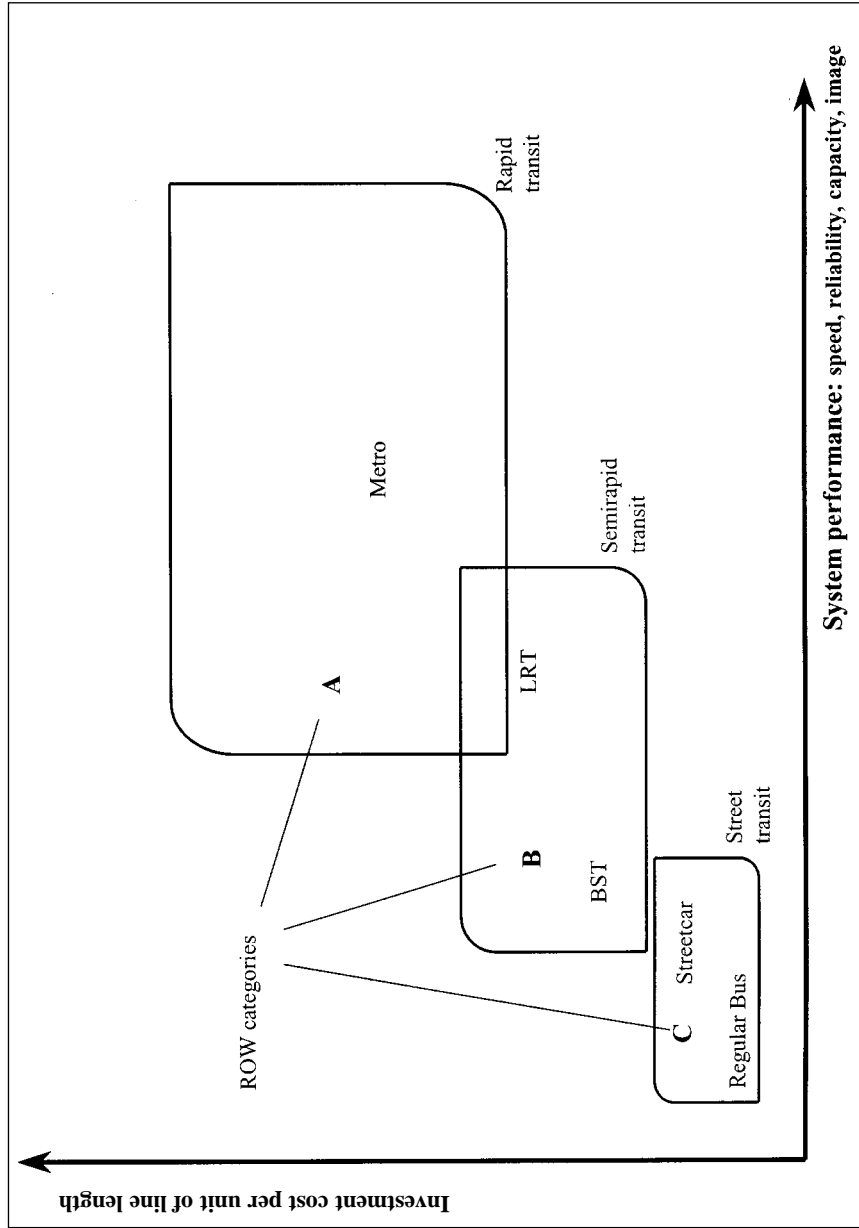

Figure 1. Performance/investment costs of modes with three ROW categories

Table 1
Characteristics of different transit modes

<i>Characteristics</i>		<i>Mode</i>	<i>Support & Guidance</i>	<i>Propulsion</i>	<i>Control</i>	<i>Cars per Transit Unit</i>	<i>TU Capacity (spaces)</i>
<i>Mode Category</i>	<i>ROW Category</i>						
Street transit	C	Bus, Trolleybus Tramway	Road/Steered Rail/Guided	ICE, Electric Electric	Visual Visual	1 1 - 3	80-125 100-300
Semirapid transit	B	BST LRT	Road/Steered Rail/Guided	ICE Electric	Visual Visual/Signals	1 1 - 4	80-180 100-720
Rapid transit	A	LRRT Metro Regional Rail	Rail Rail Rail	Electric Electric El. / Diesel	Signals Signals Signals	1 - 4 4 - 10 3 - 10	100-300 720-2500 540-1800
AGT LRT		automated guided transit light rail transit	BST LRRT	bus semirapid transit light rail rapid transit	ICE ROW	internal combustion engine right-of-way	

introducing advanced modes, such as those with electric traction, large vehicles, and trains. They allow full utilization of the high-investment ROW category A.

These definitions show that improved buses with separate lanes, as well as LRT, represent semirapid transit, rather than rapid transit. The BRT designation is a popular “sales” name, but the technically correct name is bus semirapid transit.

Correcting the Misconceptions about Transit Systems from the 1950–1970 Era

During the era of most intensive increase in auto ownership and construction of urban highways, 1950–1970, transit was neglected and features of different modes and their roles in urban transportation were often misunderstood. Some of the misconceptions about transit modes and services from that period have presented serious obstacles in planning transit systems. It is, therefore, useful to critically review some fundamental misconceptions about transit that were dominant and caused many erroneous decisions several decades ago. Four major misconceptions are discussed below.

Misconception I:

Transfers Are Not Tolerable: If Passengers Must Transfer, Choice Riders Will Not Use Transit.

This belief has resulted in attempts to provide more door-to-door services by running large numbers of complicated bus routes with very low service frequency, poor image, and low passenger attraction.

Fact I:

Intermodal, high-quality transit networks require transferring.

With good design, passengers easily accept transfers. The best transit systems (New York, Toronto, Munich, Paris) involve extensive transferring among lines and modes.

Misconception II:

Transit Can Be Provided Either by Buses on Streets, or by Rail Rapid Transit.

This planning misconception created bipolarized systems that have services represented by the diagram in Figure 1 with only street and rapid transit. It left many cities unsuited for rapid transit without any options for transit upgrading.

Fact II:

Many lines and networks need better service than buses on streets can offer, but for much lower investment than metros require.

This need has resulted in the development of LRT and BST in recent decades; these modes have filled the gap between street transit and rapid transit (Figure 1).

Misconception III:

Bus Lines Must Have Stops at Every Corner, While Rapid Transit Must Compete with the Car, Relies on Park-and-Ride, and Needs Few Stations.

This is an extreme polarization of modes by type of operation. Buses sacrifice speed for easy access: stopping at every corner creates slow, creeping bus services. Rapid transit, on the contrary, sacrifices access for high operating speed among few stations. With long station spacings, some metros designed in the 1960s do not serve many areas along their lines and discourage walk, bicycle, and transit feeders. The former loses choice riders because it is very slow and unreliable; the latter loses potential riders because it bypasses them, resulting in poor area coverage.

Fact III:

This bipolarization in access/speed ratios needs correction: fewer stops for buses, more stations for rapid transit.

Misconception IV:

Flexible Transit Systems and Services are Needed.

The vague term flexibility has been falsely proclaimed to be always a major goal in transit planning. It has been used not only to criticize transit systems, particularly rail, as “inflexible,” but also to imply that transit services which are changeable in alignment and schedules are superior to the fixed, permanent, reliable ones.

Fact IV:

Concepts opposite to flexibility are: permanence, reliability, durability, efficiency, simplicity. These are desirable features for most transit services (Vuchic 1971).

Thus, while some transit services, such as commuter lines, can be diversified in scheduling and dispersed in routing, most transit services aimed

at attracting incidental users and the general public must have fixed routes, fixed schedules, and known fares. They must be simple to understand and use. Moreover, the more fixed they are, the more they have strong impacts on land uses, as well as on quality of life in the city.

Attempts to create a higher performance bus system (e.g., BST) are aimed at giving it the feature of fixed, permanent, rather than flexible service (see Figure 2). Initially, a large number of bus routes converge on a trunk line, offering complicated, irregular service. In many cases these services are improved if the trunk is upgraded into an independent rail or BST line. Despite transfers, service on separate ROWs, attractive stations, and regular headways by one or a few rather than by many lines attract more riders. Figure 3 shows such an upgrading made in Sacramento when semirapid transit (i.e., LRT) was introduced on the trunk line, replacing many bus lines. Major ridership increases were achieved.

Family of Transit Modes and Balanced Transportation System

Experience from cities around the world has reaffirmed in recent decades the fact that there is a need for a “family of transit modes,” ranging from regular buses on streets to rail rapid transit (metro) and regional rail systems. Each major mode has a domain of applications in which it is more efficient than other modes. The neighboring modes, such as bus and trolleybus or LRT and metro, have certain overlaps in their domains.

In large cities, a single transit mode cannot provide as efficient service as several coordinated modes. The need for intermodal systems has now been recognized not only by transportation professionals but also even by laws: “Intermodal” is the concept incorporated in the title of the Federal Transportation Act of 1991, ISTEA. An intermodal system in which each mode has a role in which it is most efficient is defined as a “balanced urban transportation system” (Vuchic 1999, p. 235). “Efficiency” is used here as a comprehensive concept, including the quality of service for passengers and operating efficiency which the transit agency experiences. Moreover, the long-term impact a mode can have on the city may in some cases be a major aspect of its efficiency.

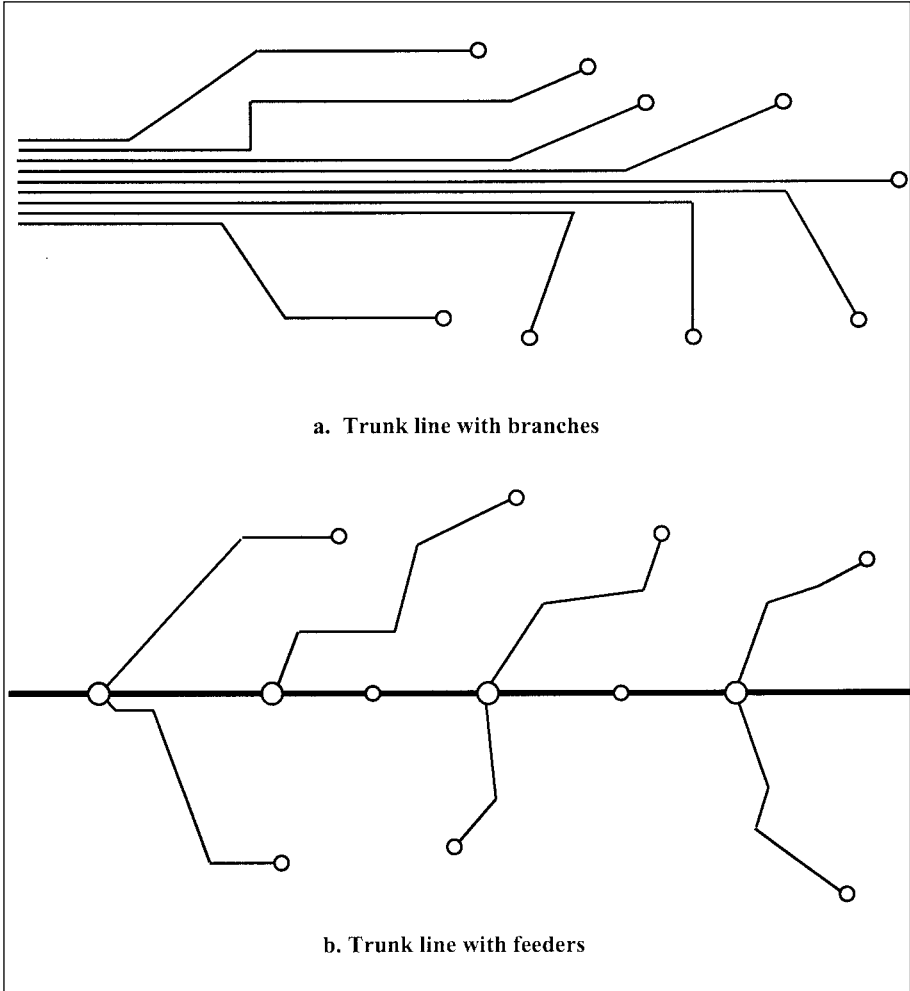

Figure 2. Radial transit trunk line with branches (a) and with feeders (b)

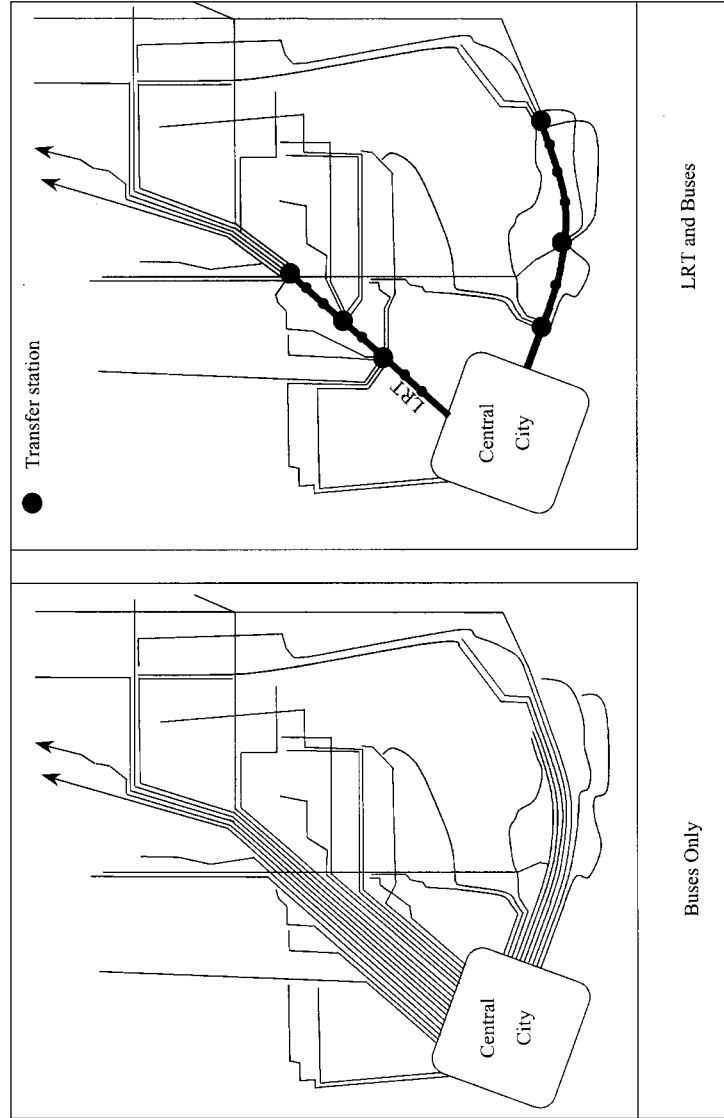

Figure 3. An example of upgrading many branch lines into a high-performance trunk with feeders (buses and LRT in Sacramento)

The need for utilization of the family of transit modes has been the reason for strong development of semirapid transit modes. The strongest representative of these modes is LRT, which has been built in dozens of world cities since the mid-1970s. In North America alone, new LRT systems have been built in about 20 cities, and their development is continuing at a strong pace. Now the development is also focusing on BST, “junior” partner of LRT in the semirapid transit category, as shown in Figure 1.

Emergence of BST as a Concept

The concept of improved buses, mostly by upgrading their ROW to category B, has been implemented in different forms since about 1970 (Peat Marwick Mitchell & Co. 1970). Many events that have occurred in this development deserve careful attention because they indicate which innovations can be efficiently introduced and which ones face many obstacles. Major developments are briefly presented and analyzed here, designated as advancements (+), various experiences (~), and setbacks (–).

+ *Introduction of BST as a system concept* (Wilbur Smith and Associates 1975; Verband Öffentlicher Verkehrsbetriebe & VDA 1979; Vuchic 1981; Vuchic and Kikuchi 1994) has led to the recognition of the following main factors needed to upgrade conventional, regular bus services into BST:

- separate lanes (ROW B), priority treatment at signalized intersections, stop spacings of 300 to 500 m, and usually vehicles designed for specific operating conditions;
- few fixed lines with frequent service (instead of many infrequent “flexible” ones);
- easy and convenient transfers among lines and modes; and
- separate infrastructure and distinct bus designs that provide a much stronger image than regular buses have.

+ *Exclusive bus lanes and busways* were built already during the 1970s in a number of cities. The best known successful busways were built in Ottawa, Pittsburgh, the Washington, D.C. (Shirley), Los Angeles (El

Monte), São Paulo (Comonor), Lima, and Mexico City (Ejes Viales). They were followed by the busways in Curitiba, in Adelaide, in several French and British cities, and O-Bahn in Adelaide.

- ~ *The commuter busways* concept was adopted in several U.S. cities instead of busways for regular BST systems. The extensive systems of busways in Houston, Seattle, Washington-Shirley HOV facility, and many others are unidirectional roadways which provide efficient commuter services to and from downtown, but they do not represent regular, all-day transit systems which constitute an integrated network.
- *The concept of HOV lanes* or roads was introduced in the United States during the late 1970s. It led to the conversion of most busways into HOV facilities. This change did improve utilization of facilities in terms of vehicles, but it benefited carpools and vanpools, while bus users experienced a distinct degradation of service and image of BST. Moreover, the new phenomenon of “ad hoc carpooling,” performed at the ramps of former busways, resulted in direct “stealing” of transit passengers. The decrease in transit ridership eventually resulted in reduction of bus services. Today, most cities allow all vehicles with two, three, or more persons to mix with buses in the former exclusive busways. Thus, in the United States, busways have virtually disappeared, with the exception of Pittsburgh and very few other cities, where they are owned by the transit agencies.
- *Bus lanes on streets* have faced a similar problem to busways. Pressure always develops to let other vehicles, such as taxis, HOVs, and trucks into bus lanes. In recent years in the United States, even HOV facilities on freeways are under attack by single-occupancy vehicle (SOV) motorists who see free-flowing lanes next to the congested lanes in which they are traveling.
- + *Bus vehicle design* has had very significant advances. These advances include new vehicle types such as “push” articulated bus, double-articulated bus, and low-floor bus. In addition, many buses now offer increased comfort, large windows, improved appearance, and cleaner engines (Hondius 1975).

- ~ *Progress with priority treatments at intersections* has been very slow. Although the technology for signal and other priorities has existed for decades (Vuchic 1981), even today in Boston, Baltimore, and Los Angeles buses with 80 persons and LRT trains with 300 to 400 persons are treated at intersections with the same rights as cars with an average of 1.3 persons. Priorities for buses are operationally and politically even more difficult to implement than for rail systems, because of their full technological compatibility with street traffic. For example, bus priorities at signalized intersections along South Busway in Miami have been suspended due to several accidents.
- *Many bus priority measures have been diluted or eliminated* due to inadequate police enforcement, as well as political pressures (Philadelphia, Chicago, Mexico). The bus lanes on Santa Monica Freeway, evaluated positively by detailed professional studies, were eliminated in the 1970s by a legal action (i.e., by a judge who was a complete layperson with respect to urban transportation). City council members sometimes force elimination of transit priorities or enforcement of parking regulations.
- ~ *Interactions with surroundings and impacts on the served areas* have varied. Good coordination between transportation and land-use planning in Curitiba (Rubinovitch and Leitman 1996) and Ottawa enabled BST systems to have positive impacts on land development around major stations and along the served corridors. In São Paulo, on the other hand, corridors along the highest capacity bus/trolleybus lines have deteriorated economically and environmentally due to the intensive noise, pollution, and separation of the two sides of the avenue. The lines suffer from rather poor image problems.
- ~ *O-Bahn or guided bus* has had unfulfilled expectations with respect to implementation (Vuchic 1985). The Adelaide system has remained the only major facility with guided buses. Even in the Seattle bus tunnel, where such a system had potential, guided buses were not introduced.
- + *Applications of Intelligent Transportation Systems (ITS) for upgrading bus services* have already been significant, and there is considerable potential for their wider use in BST operations, passenger information, and safety.

- *Deregulation of bus transit*, such as in Great Britain, has resulted in breaking up bus systems and making their technical and organizational upgrading much more difficult. For example, a very effective busway in Lima, Peru, was discontinued when deregulation was introduced. In Mexico City replacement of most bus services by deregulated minibuses has practically destroyed reserved bus lanes and other BST features that had been introduced with very positive results.

This review of the historic development of the BST concept and elements since the 1970s shows that many efforts to upgrade buses have been made. Some represent significant progress, while others met difficulties and were partially successful, or even represented setbacks. Major experiences from these developments and lessons for the future can be summed as follows:

1. Bus services are upgraded when extensive but infrequent, “flexible” bus lines are replaced by fixed routes with separate lanes, fewer but more distinct stations, and frequent service.
2. The main obstacles to upgrading bus services have been organizational and political, rather than technological.
3. Provision of separate bus lanes and roadways must be followed by their continuous protection from pressures by lobbies to share these facilities with car, taxi, truck, and other vehicle categories.
4. Most steps of bus upgrading, such as provision of separate ROW, stations, distinct trunk service with transfers from feeders, and stronger image, make bus lines more similar to LRT.
5. Successful BST systems are found in cities which have very strong planning, good traffic engineering, and a clear policy of prioritizing modes on the basis of the number of persons they carry. Ottawa and Curitiba illustrate the importance of these conditions.

Analytical Comparison of RB, BST, and LRT Modes

The “family of transit modes” shown in Figure 1 grouped the modes into three categories and located BST between RB and LRT. Therefore, in evaluating transit alternatives for upgrading transit systems, the comparison of these three modes is very common. A visual presentation of their physical, technical, and

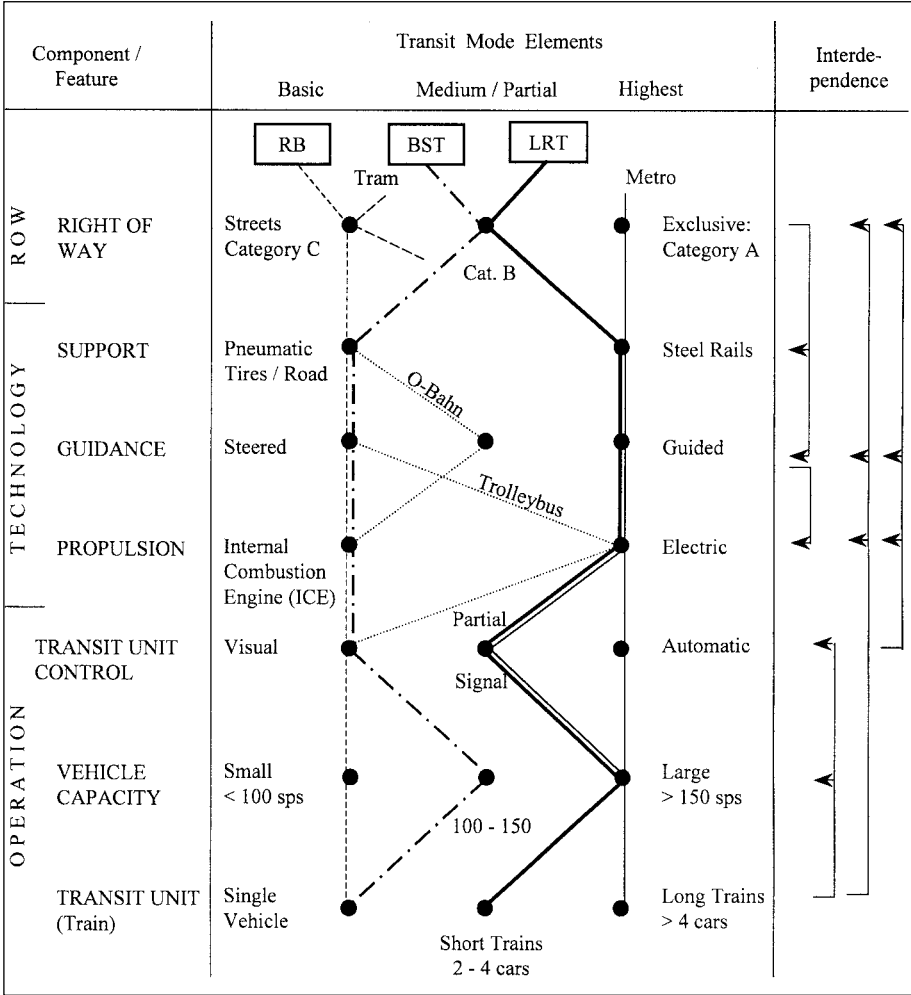

Figure 4. Graphic presentation of the physical and technological features of different transit modes

operational characteristics is given in Figure 4. This diagram is set up so that any mode of urban transportation, be it trolleybus, bus, metro, or automated guided transit, can be shown on it by a line connecting its respective components. The first section shows the most important physical component—ROW category, followed by the sections with components of technology and operation. On the left are the base-level components: single, road vehicles, steered and controlled by the driver and powered by ICE. On the right are advanced features: guided technology, electric propulsion, signal control, high-capacity trains, and others.

The lines with arrows in the last column show interdependence of features. For example, automatic operation requires electric traction, guided technology, and exclusive ROW, category A.

The basic transit system, RB, which is most economical and efficient for low-volume lines, has the components on the left side of the diagram. The highest-performance transit mode, metro with full automation, which is optimal for high-volume lines, is represented by a straight line on the right side. The lines representing RB, BST, and LRT clearly show the differences among these three modes.

BST has the same technology and driver-steered single vehicle operation as RB but different ROW category. LRT has the same ROW category as BST, but it has higher-performance technology features: guidance which makes possible use of larger vehicles and trains of up to four cars, electric propulsion, and partial signal control (used on high-speed or tunnel sections). Most other differences between these modes result from the two differences: change from ROW C on RB to ROW B on BST and LRT, and change from diesel road vehicles on bus systems to electric rail vehicles on LRT systems.

Table 2 presents components and characteristics of the three analyzed modes, RB, BST, and LRT. They are classified into three groups: system components, lines/operational elements, and overall system characteristics. Major features will be briefly discussed. (These are generalized mode characteristics, not necessarily precisely valid for each specific transit system.)

System Components

The first group, system components, summarizes the modal features from Figure 4. With respect to elements of lines and operations, typical BST systems

Table 2				
Comparative Features of Regular Bus, Bus Semirapid Transit, and Light Rail Transit Modes				
<i>Characteristic</i>	<i>Mode</i>	<i>Regular Bus (RB)</i>	<i>Bus Semirapid Transit (BST)</i>	<i>Light Rail Transit (LRT)</i>
<i>System Components</i>				
ROW		C	B (C)	B (C, A)
Support		Road	Road	Rail
Guidance		Steered	Steered	Guided
Propulsion		ICE	ICE	Electric
TU control		Visual	Visual	Visual / Signal
Max TU size		Single vehicle	Single vehicle	1-4 car trains
TU capacity (spaces)		120	180	4x180=720
<i>Lines/Operational Elements</i>				
Lines		Many	Few	Few
Headways on each line		Long / medium	Long / medium	short
Stop spacings (meters)		80– 250	200-400	250-600
Transfers		Few	Some / Many	Many
<i>System Characteristics</i>				
Investment costs/km		Low	High	Very high
Operating costs/space		Medium	Medium	Low
System image		Poor	Good	Excellent
Impacts on land use and city livability		None	Some	Strong
Passenger attraction		Poor	Good	Excellent
Legend: ICE Internal combustion engine ROW Right-of-Way T Transit unit				

have lines that are more intensive than those of RB, but still more extensive (more branches) than LRT. Bus lines and their networks have more stops, lower speed, and usually longer headways than rail lines. When an LRT line is built, the network is changed from an extensive to intensive one, with trunk and feeders, as shown in Figures 2 and 3. While intensive LRT lines involve more transfers, they are organized so that transferring is made conveniently. Usually the advantages of intensive lines with respect to frequency, reliability, and comfort are such that they more than outweigh the disadvantage of transferring.

Lines/Operational Elements

BST demonstrates that bus lines do not have to form extensive, confusing networks with long headways, which are intended to minimize transfers. Actually, in many ways, the more buses adopt operational features typical for rail lines, the more passengers they attract. This is clear from the fact that the most successful BST systems, such as in Ottawa, Curitiba, and the planned BRT systems in several U.S. cities, are created by changing them from extensive networks with many lines and close stops to major trunk lines with ROW category B, large (articulated) vehicles, longer station spacings, and transfers to feeder bus lines.

A good example of these system design and operational features are the recently introduced Metrorapid lines in Los Angeles. They represent former RB lines upgraded by several BST/LRT elements, such as stop spacings increased from 250 to 600–800 m; priority signals at intersections; high-quality buses with distinctive red coloring; strong image of lines with a special name “Metrorapid.” The result of these upgrading elements has been a significant increase of passengers.

System Characteristics

System characteristics, given in the third section of Table 2, result from system components and line elements. Physical characteristics of the bus and rail modes account for fundamental differences between the first two and the third system. Investment cost, which is very low for RB, is much higher for construction of separate BST facilities, and then even higher for electrified LRT. System image and passenger attraction improve with upgrading to BST, and even more so with LRT. Finally, impacts on land-use development along the line are generally related to the permanence and image of transit system facilities. In that respect, again RB, consisting mostly of buses on streets which can be relocated

at any time, has no impact. BST may have an impact if planning is energetically pursued, but LRT has a distinct advantage due to the greater permanence and physical presence of rails and separated ROW.

Focusing now on the two semirapid transit modes, BST and LRT, their main features can be compared in a summarized manner as follows, covering the service the passengers experience, system costs, and impacts/interactions with the served areas.

- *Vehicle performance and passenger comfort:* Due to electric propulsion and more spacious, stable rail vehicles, LRT has a distinct advantage.
- *Investment cost:* BST has a significant advantage in this respect over LRT. Exceptions may be in physically constrained areas and in construction of stations which must be greater to accommodate overtakings of buses.

Buses are also considerably cheaper than LRT vehicles, although the difference in their life cost is not as great as the difference in their purchase prices because rail vehicles have 2.5 to 3 times longer lifespans (buses last 10–15 years, LRT vehicles 25–40 years). Correct comparison must be based on life-cycle cost per unit of vehicle capacity.

- *Implementation time:* BST again has an advantage because it does not require any new technology and special installations, such as electric power supply, or signal system.
- *Operating cost:* This varies with passenger volume. Generally, operating costs are lower for buses with low-to-moderate volumes, but lower for rail when large volumes are carried, due to economies of scale of large vehicles and train operation.
- *System image and passenger attraction:* BST has a stronger image than RB, while rail tracks make LRT lines even more distinct and permanent, giving this mode a significantly stronger image than any bus lines can have.

Passenger attraction of the two modes is often discussed. Evidence from many cities shows that on a given general alignment LRT attracts considerably more passengers than BST. Examples are the substantiated ridership increases when LRT replaced buses in a number of cities, such as Calgary, St. Louis, Denver, and Dallas.

On the theoretical side, models relate passenger attraction to the parameters of transit service. If the models are developed correctly, they must reflect not only the speed and frequency of service, but also vehicle comfort, line simplicity, image, and attraction in which BST ranks between RB and LRT.

- Environmental impacts (air pollution and noise): There has been considerable progress in the development of less polluting ICEs, such as “clean diesel” and CNG engines. However, buses still produce exhaust which is objectionable, particularly in areas with high concentrations of people. It also prevents bus use in tunnels. Noise produced by buses remains a problem. For example, intensive BST corridors in São Paulo are strongly criticized for the exhaust and noise they produce along the lines.

Trolleybuses produce no gases, and they represent the quietest transit vehicle. BST systems in Quito and some in São Paulo use trolleybuses.

LRT produces no air pollution, and its noise is extremely low. This makes LRT more desirable for to center city streets and pedestrian areas than BST.

- Interaction with land development: As already discussed, LRT has a considerably greater potential to influence development of land in its service areas than BST.

Comparisons between BST and LRT are summarized in Table 3. Because bus technology requires lower investment and it is easier to implement on the lines where low or moderate capacity is needed, BST is the superior mode. LRT is generally superior for serving major transit corridors, as well as for lines which go through pedestrian areas, penetrate into urban developments for, or must use tunnels. Thus, BST is the logical solution where RB lines need upgrading through introduction of bus lanes and priority treatments, while LRT generally dominates the higher range of the semirapid transit applications.

Table 3
Comparison of Main BST and LRT eatures

<i>Characteristic</i>	<i>Mode</i>		
	<i>Bus Semirapid Transit (BST)</i>	<i>Light Rail Transit (LRT)</i>	<i>Superior</i>
Vehicle performance & passenger comfort	Good	Excellent	LRT
Investment cost	High	Very High	BST
Implementation time	Short	Medium	BST
Operating cost	Lower for low pass. volume	Lower for high pass. volume	
System image and passenger attraction	Good	Excellent	LRT
Air pollution and noise	Considerable	None	LRT
Interaction with land development	Limited	Excellent	LRT

Alignments which require expensive ROW construction (valleys, constrained areas, hilly terrain, rivers, and lakes which require bridges and tunnels) are better suited to LRT because of its higher capacity. Moreover, the additional investment in rails and electrification is well worth the superior system performance which LRT offers. In other words, if a large investment is made in ROW construction, it is usually logical to make the additional investment that would greatly improve system performance and image.

Which one of the two modes is selected for a specific case in the “middle range,” depends not only on the passenger volumes, types of lines, and estimated costs, but also on the last three items in Table 3: system image and ability to attract passengers, environmental compatibility in the served areas, and impacts on land development and quality of life. These aspects are difficult to quantify, but they may have a great significance for mode selection in many cases, because they influence the role of transit and thus the character of the city (see also Vuchic and Stanger 1973; Vuchic 2000).

Evaluation of various system aspects in selecting modes from performance, capacity, and costs to the role transit should have in the served areas depends greatly on local attitudes. In some cases transit service is considered mainly with respect to its transportation function; BST can be implemented sooner than LRT and satisfy that requirement. In others, the visual and symbolic aspects of rail transit, its sense of permanence, and positive impacts on urban character may also be given considerable importance. Such situations would favor LRT.

Conclusions: Prospects, Problems, and Future Role of BST

The prospects for implementation of BST systems are very good because there is a need for improvement of bus services in numerous corridors of many cities. Actually, potential benefits from the BST promotional program is considerably greater than implementation of several systems that can be designated as BST. Many individual elements and operational concepts of BST can be applied to regular bus services in most cities. The significance of BST is also great because it highlights the following facts:

- Bus services should be planned and operated as systems, rather than as a set of buses placed in service on certain alignments. Their ROW, stops, vehicles, and operations must be integrated in efficient transit systems.

- Many bus services can be upgraded from the present, usually slow, stopping-at-every-corner transit service for captive riders to an attractive mode of urban transportation.
- Transit vehicles, including bus and LRT, should be given preferential treatment at intersections over general traffic on the basis of their much higher number of passengers as well as their public service role.
- Reserved transit lanes should be limited to transit vehicles only. Sharing the lanes with other vehicle categories, reserving them for certain periods of time only, and reverse directional use, are sometimes good temporary solutions, but they dilute the image and decrease efficiency of transit services.

Despite the potential for BST implementation, there are serious obstacles to it. As discussed above, many attempts to implement various components of the BST mode have met with considerable resistance and obstacles. Obtaining exclusive bus lanes and preferential treatments, maintaining them, defending them from pressures to allow HOVs and other vehicle categories, are experienced in most cities. Planners of BST systems must be aware of these problems, anticipate them, and prepare how to overcome them.

Most likely conditions for successful application of BST may be defined as follows:

- corridors with many overlapping bus lines;
- streets and avenues where separate bus lanes can be introduced; and
- political and civic support for transit in traffic regulations are sufficiently strong that bus priority measures can be introduced and maintained.

In conclusion, the potential role for BST is to influence upgrading of major bus services and provide the first-level semirapid transit. It should be considered as complementary to or a stage of development toward LRT or a metro system.

References

- Diaz, R. B. and D. C. Schneck. 2000. Bus Rapid Transit Technology in the Americas. Washington, DC: *TR Record 1731*, pp. 3-9.
- Hondius, H. 1995. State of the art of bus, hybrid bus, trolleybus and intermediate systems. *Public Transport International* #6, pp. 24-31. Brussels: UITP.
- OECD Road Research Group. 1977. *Bus Lanes and Busway Systems*. Paris: OECD.
- Peat Marwick Mitchell & Co. 1970. *A Case for Bus Transit in Urban Areas*.
- Rabinovitch, J., and J. Leitman. 1996. Urban planning in Curitiba. *Scientific America*. March, pp. 26-33.
- RATP. 1977. *Autobus en Site Propre (Bus on Separate ROW)*. Paris.
- Transportation Research Board. 2001. *BRT—Bus Rapid Transit*. Washington, DC.
- Verband Öffentlicher Verkehrsbetriebe and VDA. 1979. *Bus-Verkehrssystem*. Dusseldorf: Alba Buchverlag.
- Vuchic, V. R. 1971. The concept of flexibility in transit system analysis. *High-Speed Ground Transportation Journal* 5:53–61.
- Vuchic, V. R. 1981. *Urban public transportation systems and technology*. Englewood Cliffs, NJ: Prentice-Hall.
- Vuchic, V. R. 1999. *Transportation for livable cities*. New Brunswick, NJ: Rutgers University Center for Urban Policy Research.
- Vuchic, V. R., and S. Kikuchi. 1994. *The bus transit system: Its underutilized potential*. Report DOT-T-94-20 to Federal Transit Administration. Washington, DC: U.S. Department of Transportation.
- Vuchic, V. R., and R. M. S. Stanger. 1973. Lindenwold Rail Line and Shirley Busway B. a Comparison. *HR Record 459*, pp. 13-28. Washington, DC.
- Vuchic, V. R. 1985. O-Bahn B description and evaluation of a new concept. *TR Record 1011*, pp. 8-15 Washington, DC.
- Vuchic, V. R. 2000. Comparison of light rail transit with bus semirapid transit. *5th UITP Light Rail Conference, Melbourne*. Brussels: UITP.
- Wilbur Smith and Associates. 1975. Bus use of highways. *NCHRP Report 155*.

About the Author

VUKAN R. VUCHIC (vuchic.seas.upenn.edu) is UPS Foundation Professor of Transportation in the Department of Systems Engineering at the University of Pennsylvania. He has lectured at about 70 universities and authored about 140 reports, book sections, and articles published in the United States and foreign countries, mostly on various aspects of urban transportation. His book *Urban Public Transportation Systems and Technology* (Prentice-Hall 1981) contains descriptions, analyses, and design aspects of bus, rail, and other transit modes.

One of Dr. Vuchic's specialties has been evaluation and comparative analysis of different transit modes, such as bus, semirapid bus, light rail, rapid transit, and regional rail. Dr. Vuchic wrote the first report defining light rail transit in 1973, which contributed to the introduction of LRT to North America. He also wrote a report in 1994 supporting strong upgrading of bus services which was followed by FTA's current strong promotion of "bus rapid transit."

Applicability of Bus Rapid Transit to Corridors with Intermediate Levels of Transit Demand

Graham N. Carey
Lane Transit District, Eugene, Oregon

Abstract

Bus Rapid Transit (BRT) has the potential to bridge the gap between conventional rubber-tired transit operations and rail systems. Based on relatively low-cost, proven technology, BRT is gaining acceptance in many communities around the world that are endeavoring to provide high-quality transit service. While proposed applications of this new mode vary considerably, some conditions may be more appropriate than others. This article explores, from the point of view of the practitioner, some of the benefits and drawbacks of BRT.

Introduction

As communities grow, transportation planners are faced with an increasing dilemma. There is a need for increased personal mobility, but there is a dwindling pool of funds and growing public backlash against new road construction.

While transit is purported to be the solution, existing forms of transit service are either inappropriate in most environments or considered unacceptable alternatives to the private automobile by a large portion of the population. Conventional bus services, the workhorses of the transit industry over the last half decade, have failed to keep up with the changing desires and needs of the traveling public. In recent years, light rail transit (LRT) has been extremely successful in capturing the

imagination of the traveling public. This mode does, however, require a relatively high level of patronage to support the service and is cost-prohibitive in many corridors. As it is unlikely that we will be able to develop a sufficient number of rail-based systems to meet the desires of the traveling public, we need to identify a means of providing an affordable higher level of transit service.

Over the last 30 years, transit providers have experimented with enhanced bus services that provide a higher level of service. These services, which range in form from express operations to busway projects, are viable alternatives to the private automobile. Few operations have been successful in emulating the appeal of their rail counterpart. In the late 1960s and 1970s, a number of transit systems attempted to bridge the gap between conventional bus and rail systems. These systems, referred to at the time as BRT, primarily relied on the provision of bus-only lanes on freeways and were perhaps better described as “bus highway” systems.

Since their introduction, the growth in private automobile use has produced increasing pressure for additional lane capacity, resulting in many bus facilities being converted to high-occupancy vehicle (HOV) facilities. This has further diminished the effectiveness of the service and has in a number of cases resulted in their termination.

What is it about rail-based systems that make them preferable to the traveling public? Is it their simplicity, directness of routes, look, permanence, ease of use, or speed? The answer is all of the above. To further complicate the matter, when we mention “rail,” what do we mean? For most of us the term means steel wheel on a rail. That being the case, how do we characterize the rubber-tired subway systems demonstrated in Montreal and Paris?

On a purely mathematical level, Nobel Prize-winning economist Daniel McFadden used consumer choice theory to illustrate that commuters will react, all things being equal, to a high-quality bus-based system the same as they would to a rail rapid transit system (e.g., BART). However, this has not been the case in practice. Many attempts have been made to emulate rail-based systems using a rubber-tired vehicle. These attempts have not realized the success of similar rail-based systems. There would appear to be something missing, which is probably not mathematically quantifiable.

If the bus mode is to be viewed by the traveling public as being comparable to rail-based services such as LRT, it must not only provide the same level of convenience and service but also emulate those more subjective attributes of the mode, such as its look and feel.

What Is BRT?

By definition BRT is a rubber-tired transit system that mimics the positive components of a rail-based system. We could say “like” rail rather than light rail. Before defining the components of a BRT system it is appropriate to compare conventional bus with its rail counterpart. Table 1 compares the positive and negative aspects of both modes. While bus offers flexibility in routing and is cost effective, its routing tends to be complex and it has a poor public image. Rail, while considered inflexible, benefits from a positive public image, is seen as easy to understand, and is permanent.

Table 1 Comparison of Conventional Bus and Rail Attributes		
	<i>Bus</i>	<i>Rail</i>
Pros	<ul style="list-style-type: none"> • Flexible • Cost-effective • Accessibility 	<ul style="list-style-type: none"> • Simple • Permanent • Positive image
Cons	<ul style="list-style-type: none"> • Complex • Lacks permanence • Poor image 	<ul style="list-style-type: none"> • Lacks flexibility • Costly • Poor accessibility

The relative newness of the BRT concept has resulted in varying definitions. Typically, BRT is described as combining “the quality of rail transit with the flexibility of the bus. BRT vehicles operate over a variety of travel ways and are likely to include *exclusive rights-of-way*, traffic signal priority, off-vehicle fare collection, low floor vehicles. . . .” While all the definitions list possible attributes that can be associated with a BRT system, none mandate which ones are essential to a system and which are optional. The vagueness of the definition is not without good reason. With the promise of federal attention and possible funding assistance, all transit agencies undertaking enhanced bus systems wish

the definition to be all-encompassing. This has led to a generic definition, which will only serve to dilute the overall thrust of BRT, producing a series of operating examples that fail to illustrate the true benefits of the mode.

The key distinguishing attribute between an express bus service and a BRT system is the exclusive right-of-way. Without an independent right-of-way along most of the route's path, the service offered by BRT will be severely restricted. It will not provide reduced travel time and increased reliability to lure new riders. As most proposed BRT systems will be operating in existing built-up urban environments, identifying and acquiring exclusive rights-of-way are particularly challenging. However, without them the BRT service is merely an express bus operation. Exclusive rights-of-way demonstrate a commitment to the community and its federal partners to the development of a high-quality permanent system. The formulation of a more specific definition of BRT is imperative, as it will shape future projects.

A more apt definition of BRT would be:

A flexible mode that integrates capital and operational improvements to create a faster, higher-quality mode of travel than conventional bus service. BRT projects should include, at minimum, exclusive rights-of-way on at least a major part of the corridor. In addition, BRT should incorporate the following attributes:

- *Priority at intersections: Queue jumpers and other transit priority measures at intersections can reduce transit travel time.*
- *Signal priority: BRT buses would receive preferential treatment at signalized intersections to reduce travel time.*
- *Improved passenger boarding facilities: BRT stations should have permanence and substance. Stations should also be integrated into commercial developments and neighborhoods wherever possible.*
- *Coordination with land-use planning: BRT system design and land-use planning should be coordinated to provide high-quality transit service in proximity of high-intensity land uses.*
- *Limited stations: Station spacing is lengthened to reduce travel time.*
- *Prepaid fares: Elimination of onboard fare collection reduces dwell time at stations.*

- *Level boarding: Designing the passenger boarding area at the same height as the bus reduces dwell time at stations and provides easy access for all users.*
- *Unique vehicles: BRT vehicles should be designed to meet the functional requirements of the BRT systems. The BRT system should endeavor to develop a unique identity whereby the look of its vehicles supports the overall image of the operation.*
- *Direct routing: Simple, easy-to-understand route structures with termini at major generators.*

In addition, BRT systems should also strive to incorporate Intelligent Transportation Systems (ITS) technology as much as practically possible to increase reliability and passenger expectations.

Why BRT?

BRT is an appropriate choice for many corridors because it:

- protects rights-of-way;
- utilizes existing resources;
- acts as a pathfinder; and
- garners political/community support.

Protecting Rights-of-Way

The rate of growth in travel demand is exceeding the rate at which road space can be made available. Facilities designed to accommodate 20 to 30 years of traffic growth are reaching saturation well before their time. As many communities have discovered, this race to provide enough road capacity to accommodate a rapidly expanding demand for unrestricted private vehicle use is futile. Counterintuitively, some researchers (Arnott and Small 1994) have argued that the construction of additional road capacity may, in fact, increase levels of congestion. Even if this premise is not accepted, at some point the provision of additional road capacity will be impossible—whether for reasons of land availability, engineering feasibility, or political unwillingness. When gridlock is impending, attention is usually directed toward transit to provide

the solution. Within the confines of the existing right-of-way, it is difficult for transit to provide any improvement, as transit vehicles are subject to the same traffic conditions as other modes. The only solution is to retrofit exclusive transit facilities, which requires the commandeering of existing travel lanes or the acquisition of additional rights-of-way, both of which may be politically objectionable.

To avoid such a situation, it is critical that long-range plans be developed. These plans must identify future transit corridors and take steps to protect rights-of-way so they can be utilized by transit in the future. Identification of the specific transit mode to use the tract of land is of little importance at this stage. The important point is that this right-of-way be available when needed. The old transit adage “great transit cities don’t just evolve, they are planned that way” still holds true today.

Identification and acquisition of suitable rights-of-way for transit before conditions of unacceptable congestion occur can be undertaken to benefit the purchaser. Generally in growing communities, properties along less-congested corridors tend to be residential rather than commercial, as the high travel volumes usually attract commercial developers. As the corridor becomes more highly trafficked, properties become less desirable as residences and usually are rezoned to a higher use, thereby increasing their value. Without the prospect of transit these commercial properties tend to be developed in a way that is less transit-supportive, making it difficult for transit passengers to conveniently access the development.

Identification of future transit corridors tends to reduce the urgency of purchase of the property, allowing for more thorough negotiation with the property owner.

Utilizing Existing Resources

Over a long period, a considerable amount of time and money has been spent in developing processes and structures that, together with the purchase of specialized equipment, are suitable for the particular mode. With the introduction of a new mode, new systems will need to be developed, new equipment purchased, and new maintenance facilities constructed.

The transition from one technology to another may require a complete reassessment of operational and staffing needs. Considerable staff training is involved, and new staff with different skills will need to be employed. These staff changes should be negotiated with organized labor groups to ensure a smooth transition.

To maintain stability within the transit operating authority, it is important to utilize available resources to their full extent and build on the strengths of the organization rather than disregard present structures and introduce an all-new system.

The BRT system, therefore, allows the operating authority to “consume” the assets (i.e., get the most use out of them) while positioning itself for more advanced modes/operating systems.

Acting as a Pathfinder

It is not uncommon for the development of a rail-based system to exceed 10 years. The estimation of future passenger demand for a service that is only to be introduced within a decade is, at best, an imprecise science. Using results of new systems that have been initiated during the last 10 years, we have been able to refine the process to more accurately reflect likely conditions. Since the demographics of each corridor vary, the transferability of data from other systems can provide some indication of likely events, but it is far from precise. BRT systems, with their short “gestation period,” allow operators to validate passenger demand for a higher level of service, thus reducing the risk of service failure. BRT provides an opportunity to partly replicate service and operational characteristics of a higher mode. If prerequisite thresholds of demand for the higher mode are developed, then its introduction will be better assured of success.

With the introduction of a higher mode, such as LRT, a number of services associated with the mode must be fully operational from the onset. These services include fare collection, traffic signal priority, electrical supply, and communications. Ensuring complete operation of these services at the beginning is a difficult task, and their failure can lead to a poor perception of the new system.

Introducing aspects of a future service as part of the BRT operation allows the provider an opportunity to fine-tune the components of the system and to

concentrate on a limited number of key components. When the higher mode is introduced, many of the components will be fully operational and fewer “teething” problems will occur.

Garnering Political/Community Support

All indications from the Federal Transit Administration are that local communities will have to provide a higher proportion of the funding for their major capital projects. To date, the larger capital projects have benefited from copious financial contributions from the federal government. With nonlocal funds bearing the lion’s share of the financial commitment, those community members not directly impacted have tended to be indifferent to the project. However, this increased demonstration of financial support by the community will attract a far higher level of scrutiny. Exacerbating the situation will be the perception that one large capital project is consuming funds that could be distributed over the whole service area.

At the community level, the leap from one technology to another can cause concern. In communities with an engaged citizenry, there will be a variety of solutions presented to address the transportation need. These solutions are likely to vary from belief that there is no problem and resultantly no need to do anything to a feeling that there is an immediate need and a high-technology solution is appropriate.

Increasingly, the community is becoming more involved in the planning of its neighborhoods. Thus, proposals must be justifiable and defensible and all appropriate alternatives should be thoroughly evaluated before recommending a direction forward. This increased scrutiny means that any attempt to force an inappropriate solution will undoubtedly be met with vociferous comment.

BRT provides the opportunity to develop a high-quality mass transit system in a stepwise, incremental manner. Lower-cost investments can be made in the system accordingly. Time should be allowed for the benefits of the improvement to accrue and ridership to respond. Then further investments can be made. Metro Rapid in Los Angeles is good a example of a community that is using this strategy to develop its BRT system.

From a community standpoint, this is a fiscally responsible approach. The BRT system is seen as a logical step forward—by enhancing what is already in existence, without overextending the financial means of the community.

This approach also provides a logical process that addresses the needs of the proponents of rail-based systems without compromising the future need for a higher mode. In addition, BRT allows time for more in-depth debates as to the appropriate timing of a rail-based system.

Why Not BRT?

Whenever a new innovation becomes available, there is a tendency to try to apply it to every situation as if it were the panacea to all transit problems. On the one hand, it is encouraging that a new mode is considered, thus extending our toolbox of available techniques. On the other hand, the inappropriate application of a mode is likely to have a negative effect on the industry and impact the introduction in more suitable environments. Clearly, a thorough, unbiased assessment of the alternatives should be undertaken during the project development stage to ensure that the most appropriate mode is selected. The adage of “the right horse for the right course” is relevant.

Of concern are some of the most widely propounded benefits of BRT. The newness of the mode has meant that insufficient experience has been gained to verify these claims. Some of these benefits require careful consideration, as they may be some of the strongest reasons for not introducing the mode. “Benefits” that require caution are:

- flexibility,
- ease of implementation,
- low cost, and
- implementation speed.

Flexibility

Flexibility of routing was one of the key motivations for the move away from the streetcar systems that were prevalent worldwide during the first half of the 20th century. The ability to avoid congestion and to change routes in response to new developments was a major factor in the growth of the diesel-driven motor bus. While the streetcar system was beset with reliability problems, the move to the diesel coach resulted in the loss of a number of collateral benefits that were

implicit in the streetcar. One of the principal benefits of streetcar operations was the system's permanence.

During the era of the streetcar, the transit route was a clear demarcation of the major thoroughfare of the community, providing an axis on which the urban core could develop. It was obvious how transit users entered the area and developers responded by orientating buildings toward the transit routes to maximize their exposure. In contrast, the introduction of the diesel bus provided flexibility of routing. This flexibility also made it easier for the bus route to be relocated should traffic congestion become insufferable at a particular location. The introduction of the diesel bus also gave the route planner the flexibility to adjust route alignments to respond to development trends.

However, this flexibility affects the perception of the transit service. The reasons for the difference in perception are unclear; however, the resultant bias toward rail-based systems is well documented.

In addition, when the transit route has permanent infrastructure along a corridor it becomes part of the urban structure, which has to be "worked around" rather than merely relocated.

Ease of Implementation

Much has been written about the ease of implementation of bus systems over rail systems. In rail-based operations, it is necessary to relocate underground utilities due to corrosion and maintenance. The need to relocate utilities is a cost element that can consume a considerable part of the budget. If the project estimates are reasonable, though, they will be unlikely to impact the ease of implementation. When it comes down to it, the component that complicates the introduction of a rail-based system is the same as would complicate a complete BRT system: right-of-way. BRT enables a community to reserve rights-of-way before congestion is a major problem and roadway capacity expansion is no longer possible. But the task of reserving these areas is not easy. In situations where congestion has not reached intolerable levels, it is difficult for a community to understand the need to provide additional transit capacity, particularly when the general public sees few people using transit or when congestion levels are so low that there is little incentive to use transit. In communities that have experienced

high levels of congestion in other corridors and have developed mass transit solutions, this is less of an issue.

The use of “eminent domain” or other involuntary land acquisition methods for the purchase of rights-of-way for a BRT project are more difficult to justify to the public. The use of such land acquisition methods may be subjected to legal challenge and, at a minimum, will result in negative media coverage.

Because of their large price tags, rail-based systems tend to enjoy more political support, which is very useful when public reception is less positive. This lack of political mass that most bus-based systems experience can make the most nonsensical concern an issue.

Low Cost

In an era of increased competition for federal funds, any means that allow for more efficient distribution of funds among a large number of communities is clearly attractive. BRT provides such an opportunity.

If BRT is going to be financially accessible to a large number of communities, it must be affordable. This will generally require communities to deploy lower-cost, proven technologies. Depending on the design of the system, the cost can be as low as 10 percent of an LRT system. Few communities have the resources to research and test new technologies so the components should be “off-the-shelf.”

As it is not necessary to relocate underground utilities or provide an external power source, a BRT system could be constructed for far less than a comparable LRT system, while providing similar performance. BRT’s low cost can also extend into service provision. With no overhead wires to maintain or tracks to grind, maintenance costs are reduced. Also, the use of dedicated lanes reduces the wear and tear on the vehicles, as traffic conditions are predictable and fewer emergency braking situations are likely to occur.

How can low cost be detrimental to the development of the system? While it is not so much the perception that the more we pay the better the product must be (although that does play into the equation), this is the political effect of a low-price alternative. Undoubtedly, the bigger the price tag the more attention an item is given. Few bus-based systems can afford to build a statue of a politician along

the route, so the project tends to attract little attention. Most critical is the need for a political champion. There are a number of times during the development of the project where a committed political proponent is essential. Without such an advocate, the project can languish in a maze of additional information needs with no one willing to shepherd the decision-makers to a decision.

The motivation behind the introduction of BRT needs to be clearly communicated. In some communities that already have an established rail system, BRT has been proposed as an alternative to the expansion of the existing system. Public reaction to such proposals has been particularly hostile, as community members perceive the relatively new concept of BRT as an inferior alternative. In many cases, the BRT alternative has been motivated by lack of funding and is promoted as the only affordable alternative.

Implementation Speed

The general perception within the transit industry is that the introduction of BRT service is similar to redesigns of service that transit providers do on a regular basis. The primary focus is on ensuring service delivery elements, such as schedule, operator, and route. This gets back to how BRT is defined. If the application of BRT is more akin to an “express bus,” the above service delivery elements will suffice. However, if the desire is to create a service that mimics a typical light rail system, then the process is more complex. Essentially, if federal funds are utilized, the process for a release of the funding and the associated approval process are identical. During some of the earlier BRT projects, it was considered acceptable to undertake a less thorough environmental process. The extents of project impacts are now more fully understood and a more rigorous Environmental Impact Statement (EIS) must be produced, rather than an Environmental Assessment (EA).

The absence of a political champion can also impede the local decision-making process. The lack of political will to move a bus-based project with little in the way of political collateral benefit can extend project approval over what would normally be expected of a larger project.

As most BRT projects are relatively low cost, there are many funding options available that can reduce the reliance on federal monies and the processes attached to acquiring them. Also, the reduced infrastructure needs lessen some of the design complexities.

Further Considerations

For BRT to be successful, a number of obstacles must be cleared before the mode can reach its full potential. Economists have shown that many factors contribute to transit use. This section examines three of the more pertinent factors associated with the success of a BRT system. The first two, poor image of the bus and rail-like vehicles, are qualitative variables not accounted for in consumer choice models. The third factor, exclusive rights-of-way, while directly quantifiable, also impacts the public's perception of the mode.

Poor Image of Bus

During a public meeting a citizen once described bus transit as “for people who not only didn't own a car but don't even know anyone who owns one.” This perception that bus riders have no other alternative is fairly widely held. The use of terms such as “loser cruiser” by teenagers to describe conventional bus services reinforces the view that the private automobile is the only form of motorized transportation worth considering. One constant concern raised by transit professionals is the poor public image of the bus. While there are probably a number of examples of unmaintained equipment, dirty, poorly operated systems, the inferior perception of the mode is more ingrained into society than we think. The public image is cultivated at a young age, an example being in children's books where the rail or cable car is depicted as being a clean friendly mode whereas the bus is pollution producing, nasty, and dirty (Burton 1997). Increased public awareness of environmental issues has focused attention on the diesel-propelled vehicle with emissions directly in the operating area. Recent improvements in the efficiency of the diesel engine have largely gone unnoticed by the general public, as it seems that no matter how environmentally friendly a vehicle may be, the negative images conjured up by the word “diesel” are difficult to overcome. However, improvements in engine technology have been relatively recent and available budgets have not allowed operators to change their older, less environmentally friendly vehicle. The introduction of more efficient engine technology tends to occur over an extended period as most buses have an operating life in excess of 12 years.

To overcome this bias, BRT services should endeavor to differentiate themselves from conventional bus services as much as possible. Several key factors distinguish the two service concepts. These factors either reduce delays or elevate the perception of a higher-quality service.

The general perception that buses are very slow is reinforced by the fact that motorists are held up by buses loading passengers. By removing the bus from the travel stream, the perception of constantly passing buses is reduced. Further exasperating the situation is the misguided belief that the more access points to the service, the greater the ridership. The increased number of stops, rather than attract users, serves to frustrate those passengers already onboard. It has been demonstrated with the introduction of light rail systems that passengers are prepared to walk further to obtain a higher level of transit service.

Rail-like Vehicles

Clearly the traveling public reacts differently to rail vehicles than they do to conventional buses. During the last 20 years, rail-based systems have been successful in attracting the choice rider. Barring the development of the low-floor vehicle, the conventional bus has not varied in appearance since its inception. Other factors, such as vehicle length, occupancy, capacity, engine capacity, and supplier track record, have driven the vehicle selection process. The look of the vehicle was not considered an important attribute. Still today, many senior-level managers of major transit agencies believe vehicle look is not an important attribute and that service is paramount to the passenger. While service is critical and usually a poor experience will not bring a consumer back, it is the attractiveness of the vehicle that initially “brings them through the door.” As many marketing professionals note, the most difficult task is getting the customer to try a product in the first place. Once they experience the product, it is the service that maintains the consumer’s interest.

Bias toward rail-based service is well established and is utilized in the transportation process by modelers. The exact reason for this bias is unknown; however, there is a series of factors that contribute to it. These factors relate to the service rather than the vehicle and tend to include the directness, simplicity, ease of use, and the general perception of being fast.

Acquisition of a rail-like vehicle is a more difficult task than originally thought. While European manufacturers have responded directly to this need, U.S. manufacturers have not. Restrictions on the procurement of European-built vehicles in the form of “Buy America” legislation and federal vehicle testing requirements only add to the frustration of the proposed BRT operator.

Exclusive Rights-of-Way

Of all the elements that make up a BRT system, it is the exclusive right-of-way that causes the most controversy. This attribute most directly impacts the individual property owner. The effects can range from restrictions of on-street parking to the acquisition of frontage. Even in communities with high public transportation usage, impacted community members will challenge the need for right-of-way expansion for the development of a transit system. The situation is further complicated by poor public perception of the bus. The public seems willing to make more accommodations for a rail-based system than for a bus-based system. Part of the problem can be traced to the amount of nontransit improvements that accompany a project. These improvements include landscaping, public art, and bicycle and pedestrian facilities. Typically the size of associated non-transit improvements has been larger with a rail project than with a bus project. Bus-based projects tend to focus on service provision alone. In the overall scheme, a 1 percent public art budget in a rail project results in far more visible community products than a similar percentage in a lower-cost bus-based project.

While the allocation of exclusive rights-of-way is challenging, it is a key attribute of BRT. In addition to providing a number of service benefits, such as reducing travel times and improving reliability, its principle benefit is in the statement a community is making with respect to public transportation. The exclusive right-of-way renders a sense of permanence to the system and signals to the development community that high-quality transit will be available into the future.

The degree of exclusive rights-of-way depends on the environment in which the BRT facility is being located. The more exclusive the facility, the greater the impact. Facilities that are physically protected from entry of nonauthorized vehicles offer the most benefit to the BRT service. Extreme care should

be taken not to bifurcate the community so that it is inconvenient for movement across the facility. The widening of an existing facility may result in a facility that is out of scale with the surrounding area, adding more impervious surface and transforming a collector-type street into a street that feels like a major arterial. Removal of on-street parking can have a similar impact on the “feel” of an area, by eliminating the collateral traffic-calming benefits. In positioning a BRT facility in an existing street environment, median running systems are most desirable from an operational and perception standpoint. Median lanes tend to set transit apart from the rest of the transportation system and clearly differentiate it from conventional bus services. The major concern relating to median locations is passenger access, as all access requires crossing at least part of the street. If vehicular access across and into the BRT facility is controlled, then higher operating speeds are possible. A median-operating arrangement also makes it possible for the number of bus lanes to be reduced in constrained areas. Curbside bus lanes are less efficient, as access to adjacent driveways must be maintained and BRT vehicles experience considerable delays as a result. Also, enforcement of curbside bus lanes is difficult from both a recognition and apprehension point of view.

Conclusions

Few transportation planners believe that we can build enough road infrastructure to fully meet the demand for private automobile travel. Most professionals believe that a balanced transportation system of private automobiles, transit, bikes, and pedestrians is the most reasonable solution. However, if transit is to provide the much-needed relief to our congestion problem and be considered a viable alternative to the automobile, then it must attract the choice rider. It has been demonstrated that choice riders are attracted to rail-type transit systems, therefore BRT systems must endeavor to mimic the positive characteristics of these services.

Although BRT provides an opportunity for transit providers to supply a higher level of service than a conventional bus service, BRT is not the panacea to all our transport ills. Being a relatively new mode, the public has had little opportunity to experience it and are still defining it by previous

experiences of conventional bus services. BRT has a long way to go to prove itself as a viable mode to the general public. Although BRT offers the promise of meeting a range of travel needs, planners must be aware of its limitations in order to not raise false expectations.

References

Arnott, R., and K. Small. 1994. The economics of traffic congestion. *American Scientist* 82: 446–455.

Burton, V. L. 1997. *Maybelle the Cable Car*. New York: Houghton Mifflin.

About the Author

GRAHAM N. CAREY (graham.carey@ltd.lane.or.us) is the project engineer for Lane Transit District's BRT project. In serving this project, Mr. Carey is responsible for all technical aspects of the BRT project. His primary professional focus is in the planning and design of bus-based transit systems. Previously, he was general manager of JRH Transportation Engineering and director of the Johannesburg Transit District, South Africa. He is a registered Professional Engineer (PE), certified planner (AICP), and fellow of the Institute of Transportation Engineers (ITE).

Detection Range Setting Methodology for Signal Priority

*Peter Koonce and John Ringert, Kittelson and Associates
Tom Urbanik, University of Tennessee
Willie Rotich and Bill Kloos, City of Portland*

Abstract

A significant amount of delay to transit vehicles in urban areas is caused by traffic signals. Implementation of signal priority has the potential to reduce control delay caused by traffic signals. The implementation of these systems requires engineering studies that address both transit and traffic signal operations. A comprehensive program requires coordination between the transit agency and the transportation department to address needs of both agencies and users. The City of Portland and the Tri-County Metropolitan Transportation District of Oregon (Tri-Met) have been working on a program that exhibits the elements of such an effort. This article details the efforts of the project and the methodology for developing signal timing and detection distance settings.

Introduction

The City of Portland and Tri-Met have undertaken a program to improve bus service by implementing a signal priority system. The current project is the result of several years of experimentation with various techniques (Kloos and Turner 1999). The system in place uses a 170 HC11 traffic controller, an evolutionary piece of hardware, as part of an eventual upgrade to a 2070-like Advanced Traffic Controller (ATC). The Wapiti software used by the City, the Oregon Department of Transportation (ODOT), and most of the neighboring jurisdictions has been

upgraded to provide added bus priority features. The implementation allows green extension for the bus phase and red truncation when in nonbus phase(s) while also maintaining coordination. The 3M Opticom system is used as the detection system, and an automatic vehicle location (AVL) system is used to control the emitter.

This research summarizes the issues associated with the implementation of signal priority, specifically the determination of a detection range for an intersection. The detection range for the buses is determined by the location of bus stops upstream of the traffic signal, sight distance to the intersection, extension time available at the intersections, and location of the nearest upstream traffic signal. This article describes the key factors for distance setting and recommends rules for implementation of the range setting. In addition, it examines the bus priority distance setting at one intersection in more detail, providing a summary of the applications and constraints using actual headway and detection range values.

Background

Portland has a long history of providing signal priority for transit. The light rail system, Metropolitan Area Express (MAX), began service in 1986 with high priority or preemption at many of the signals. The level of priority has steadily increased, allowing more efficient travel between the stations.

Bus priority experience has included three field tests: Powell Boulevard Pilot Project in 1993, Multnomah Boulevard test in 1994, and Tualatin Valley Highway test in 1996. The Powell Boulevard test has been the most publicized (Kloos, Danaher, Hunter-Zaworski 1994). This study evaluated several detection technologies for inclusion in the system. The technologies included the TOTE system by McCain, the LoopComm system by Detector systems, and the Opticom by 3M. Signal priority algorithms were limited in these tests to preserve traffic signal coordination. In each of these tests, Portland's Bureau of Transportation worked with Tri-Met.

Transit signal priority measures include passive, active, real-time, and preemption.

- *Passive* strategies attempt to accommodate transit operations through the use of pretimed modifications to the signal system. These adjustments are completed manually to determine the best transit benefit while minimizing the impact to other vehicles. Passive priority can be simple changes to the signal timing or systemwide retiming to address bus operations. The strategies can utilize transit operations information, such as bus link travel times, to determine signal timing coordination plans.
- *Active* strategies adjust the signal timing after sensing the arrival of a bus. Depending on the application and capabilities of the equipment, active priority may be either conditional or unconditional. Unconditional strategies provide priority regardless of the transit vehicle status (i.e., regardless of passenger loads or lateness).
- *Real-time* strategies are implemented by systems that provide continuous feedback between the priority request generator (the bus) and the priority request server (unit that discerns which request to serve). Real-time strategies may also use estimated arrival time information at the intersections to make control decisions within the system.
- *Preemption* could be classified separately because it results in changes to the normal signal phasing and sequencing of the traffic signal. Preemption is most commonly associated with emergency response vehicles and trains. Preemption affects the normal operation of the traffic signal and the resulting traffic flow, which has the potential to impact the safety and efficiency of the intersection. One of the most important effects is the disruption of coordination between traffic signals, which may result in significant congestion.

The Portland application, as in many other cities, is focused on active priority that make changes to the signal timing to accommodate buses while remaining in a coordinated system of traffic signals.

System Description

Tri-Met is a regional transit agency that serves the three county area in Portland, Oregon. Tri-Met operates 101 bus routes, as well as light rail and para-transit services for seniors and people with disabilities. Tri-Met has continued to

grow transit ridership by offering exceptional service and continually working to improve the system.

The agency has developed an Intelligent Transportation Systems (ITS) plan to ensure the Portland region is well prepared to realize the benefits of ITS. Tri-Met has planned projects that support regional integration, build on the agency's existing infrastructure, and offer opportunities for future ITS expansion (Parsons Brinkerhoff, Batelle 2001). One of the 12 projects included in this plan is signal priority. The initial scope of the signal priority project is to provide priority at 250 traffic signals on seven routes in the City. Total project cost is estimated at \$4.5 million with initial field installation, completed in July 2001, and field-testing to be completed by summer 2002.

Tri-Met has been using AVL to monitor and control its bus operation for two years. The AVL system uses onboard Global Positioning Systems (GPS) receivers to monitor the buses via the Bus Dispatch System (BDS). The BDS system, developed by Orbital Sciences Corporation, is connected to the vehicle's onboard computer, which contains route and schedule information. Integration of this information allows the bus to determine schedule status on a real-time basis. This permits the Smart Bus concept to only allow the bus to activate the Opticom emitter when the vehicle is behind schedule and if certain other criteria are met.

Project Description

The first phase of the project involved implementation on Route 104–Division and Route 4–Fessenden in Portland. The Division route operates mainly on SE Division Street. The bus route travels through 31 traffic signals (in each direction), along 10 miles of roadway, extending from downtown Portland to the City of Gresham. The extent of the signal priority project is within the city limits of Portland outside of the city center, stopping 3 miles west of the bus route's eastern terminus, downtown Gresham. This corridor carries 6,500 riders per day with an average load of 26 passengers.

The Fessenden route is more circuitous, traveling on several arterials and collectors in North Portland. The route is approximately 9 miles in length with 33 signals on the outbound route and 25 signals on its inbound route. Portions of the route operate on a couplet outside of the downtown. The Fessenden route carries 7,820 riders per day.

These routes were good candidates for signal priority because of the spacing of signals, their ridership, and headways (7 minutes during the peak hour). The corridors also have a number of simple two-phase intersections, which are simplistic from the traffic engineering perspective. Further, because of the nature of the routes and lower traffic intensities, changes to the signal timing were of less concern on several of the intersections.

An additional advantage of selecting the Opticom system in Portland is that along with signal priority, the traffic signals are also upgraded with emergency vehicle (fire and emergency medical services vehicles only) preemption equipment. The majority of the traffic signals on these routes previously did not have preemption equipment installed because the intersections predated the equipment.

Methodology

Signal priority consists of two components: the bus must be detected by the traffic signal and the traffic signal must accept the request for priority. As described above, Portland evaluated several detection methodologies in its pilot project and determined that the Opticom system by 3M would be utilized for bus detection. The Opticom system is currently the most widely used priority and preemption detection system in the United States.

Bus Detection System

The challenge for implementing the concept successfully is the detection system, which must place a call at an appropriate time in order to be effective. A call placed too late during the bus phase can result in a missed opportunity. A call placed too soon can result in the provision of green time that cannot be used effectively.

The Opticom system is relatively simple: data are transmitted from the bus to the traffic signal via an emitter and an optical detector. An emitter mounted on the bus is activated to send an encoded message to the traffic signal. A detector located at the intersection receives the signal and converts it to a message to the controller. A phase selector within the controller cabinet makes the request for priority within the traffic signal controller and also logs the information within the unit.

Opticom can provide two pieces of information. First, the system requests an immediate request for service. This request for service can be controlled in two ways. The bus, using the Smart Bus concept, controls the time of the request. The detection range setting of the Opticom receiver controls the time of the request. The Opticom transmitter can also provide a bus identification number, which can be used to distinguish bus types. Setting the distance for the detection range provides an opportunity to increase the usefulness of the priority request by requesting priority at a location that increases the likelihood that the bus will progress through the signal during the priority call. Other criteria that control the emitter within the Smart Bus concept are shown in Figure 1. The Smart Bus only activates the emitter when the bus is on route, in service for passengers, its doors are closed, or when the bus is running late. The threshold for determining whether the bus is late is set at 90 seconds. Once the bus has reached this threshold and is behind schedule, the emitter will be active until it has gained 60 seconds and is less than 30 seconds behind schedule.

Traffic Signal Timing

The traffic signal software used by the City provides a range of priority and preemption options as well as recovery options to reduce bus delays. The strategies are in place throughout the day while buses operate on the system. Priority can be requested on any of the legs of the intersection. The maximum extension is constrained by intersection elements, but range from 0 to 40 seconds. The truncation also is dependent on the configuration of the intersection. Table 1 summarizes some of the limitations associated with the signal timing as it relates to bus operations.

During this implementation, red truncation and green extension are utilized to provide priority. The basic concept of green extension and red truncation is generally well understood. The maintenance of coordination requires that the phase length changes be implemented within the constraints of the overall cycle length; considerations include minimum walk time, flashing DON'T WALK time, and minimum vehicle green time.

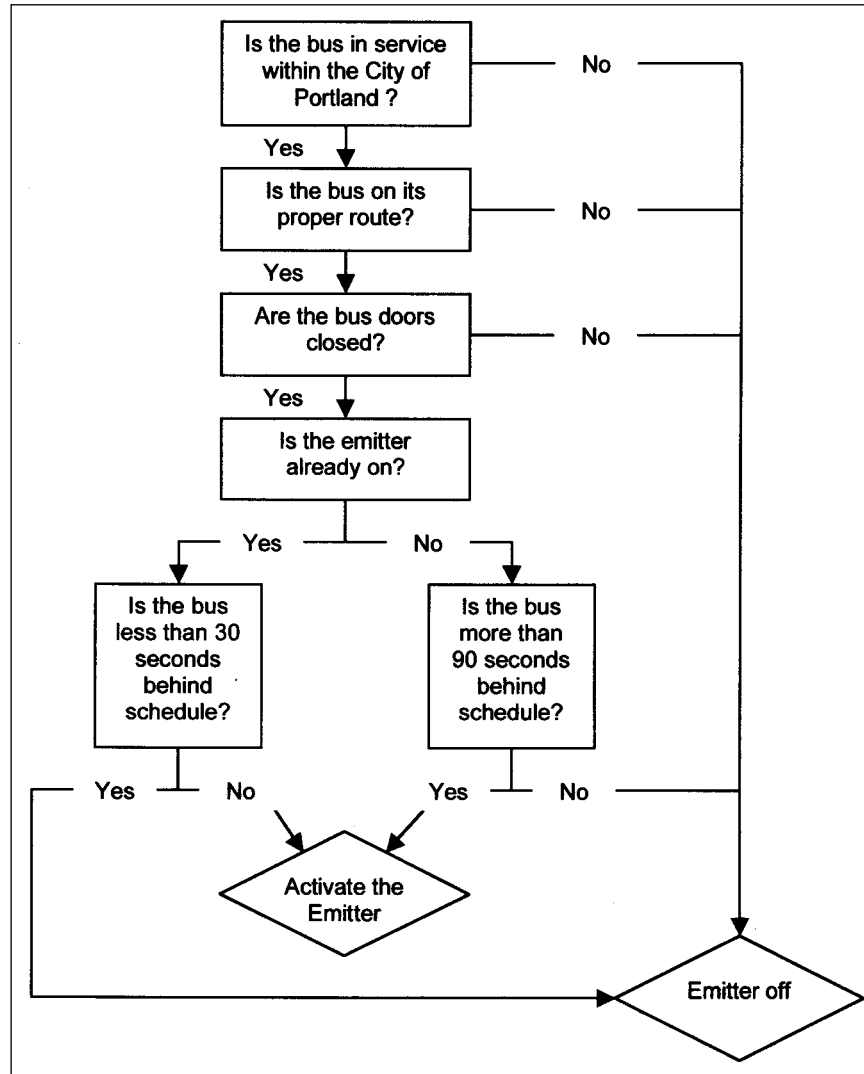

Figure 1. Decision framework for emitter activation

<i>Parameter</i>	<i>Limitation</i>	<i>Comment</i>
Pedestrian detection	Lack of pedestrian detection (push buttons for actuation) requires the opposing pedestrian phase to time every cycle	Presence of pedestrian detection increases the potential responsiveness of the intersection to serve transit
Pedestrian timing	Time for flashing Don't Walk cannot be reduced in any case	Pedestrian detection reduces the need to recall pedestrian phases each cycle, thereby improving the responsiveness to transit
Multiphase intersections	Phase skipping is not allowed in the State of Oregon; thus minimum vehicle times and clearance times must be considered for all phases (legislative limitation)	Additional phases at intersections increase the amount of required time for service
Cycle lengths	Low cycle lengths reduce the flexibility of the engineer to extend the timing provided to the bus, although may provide better responsiveness overall	The trade-off between flexibility and efficiency at the intersections has been consistently discussed; lower cycle length typically improves bus operations

Priority Decision Logic

The time the call is entered dictates the response of the controller. The controller logic determines whether to use green extension (extend a current green indication for the bus) or red truncation (shorten other nonbus phases), depending on whether the controller is in the bus or nonbus phase, respectively. In the case of a simple two-phase intersection, the logic is simplified, and for purposes of discussion, this case will be reviewed. To set the detection range, both extension and truncation must be considered to determine an appropriate distance from the intersection. A procedure developed as a part of this project establishes the location of Opticom detectors on the bus line and determines the range at which the detector will identify the bus and initiate the bus priority plan. As shown in Figure 2, the decision is based on the current status of the bus phase when the call is received.

Priority Distance Setting

Establishing the priority distance is a critical portion of the implementation. Ideally, the detection would occur at the furthest upstream point to give advanced

notice for the approach of the buses. Because the Opticom system results in an immediate request for service, the distance from the traffic signal at which the call is received dictates the length of the extension possible. To address limitations, the detection range is set to reduce the length of the call based on the amount of priority time that is available within the extension portion of the priority service. Essentially, the length of advance time that can be accommodated is limited by lack of knowledge on the desired time of service and limitations in the controller software’s decision-making logic. The maximum advance time is the length by which the bus phase can be extended.

For purposes of further explanation, a simple two-phase intersection with buses on both phases will be described. While simplistic, the explanation is also practical because the intersection of N. Albina Avenue and N. Killingsworth Street is exactly this configuration. As shown in Figure 3, Route 4 Fessenden operates on phase 2 (N. Albina Avenue) and Route 72 Killingsworth operates on the cross-street phase 4. At this intersection, the coordinated movement is Killingsworth Street (the north–south movement).

Green Extension Distance-Setting Procedure

The green extension plan is used when the call is received on a phase that is already green (i.e., a call on phase 2 is received from Route 4 while phase is

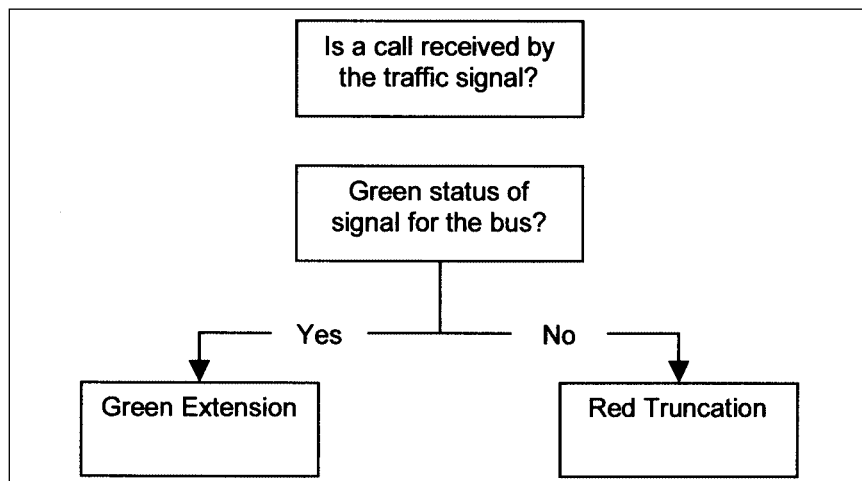

Figure 2. Decision framework for priority plan selection

Table 2 Traffic Signal Timing Descriptions	
<i>Treatment</i>	<i>Description</i>
<i>Passive Priority</i>	
Adjust cycle length	Reduce cycle lengths at isolated intersections for the benefit of the bus.
Split phases	Introduce special phases at the intersection for the bus movement while maintaining original cycle length.
Areawide timing plans	Preferential progression for buses through signal offsets.
Bypass metered signals	Buses use special reserved lanes, special signal phases, or are rerouted to nonmetered signals.
Adjust phase length	Increased time for approaches with buses.
<i>Active Priority</i>	
Green extension	Increase phase time for current bus phase.
Early start (red truncation)	Reduce other phase times.
Special phase	Addition of a bus phase.
Phase suppression	Skipped nonpriority phases.
<i>Real-Time Priority</i>	
Intersection Control—Delay	Signal timing changes to reduce overall person delay.
Optimizing Network Control	Signal timing changes considering the overall system performance.
<i>Preemption</i>	
Preemption (Unconditional)	Bus phase begins when all other intervals are satisfied.
Preemption (Conditional)	Same as above except certain conditions are used to determine when the bus phase should begin.

green). See Figure 2. The controller coordination timing and the demand of the side street limit the amount of green extension that can be provided. Assuming a call is received before the onset of yellow for the bus phase, the extension of the bus priority algorithm will start timing at the yield point. If a call was received at the yield point in this case, the extension time would be equal to the travel time between the detection point and the intersection. This represents the worst case under extension.

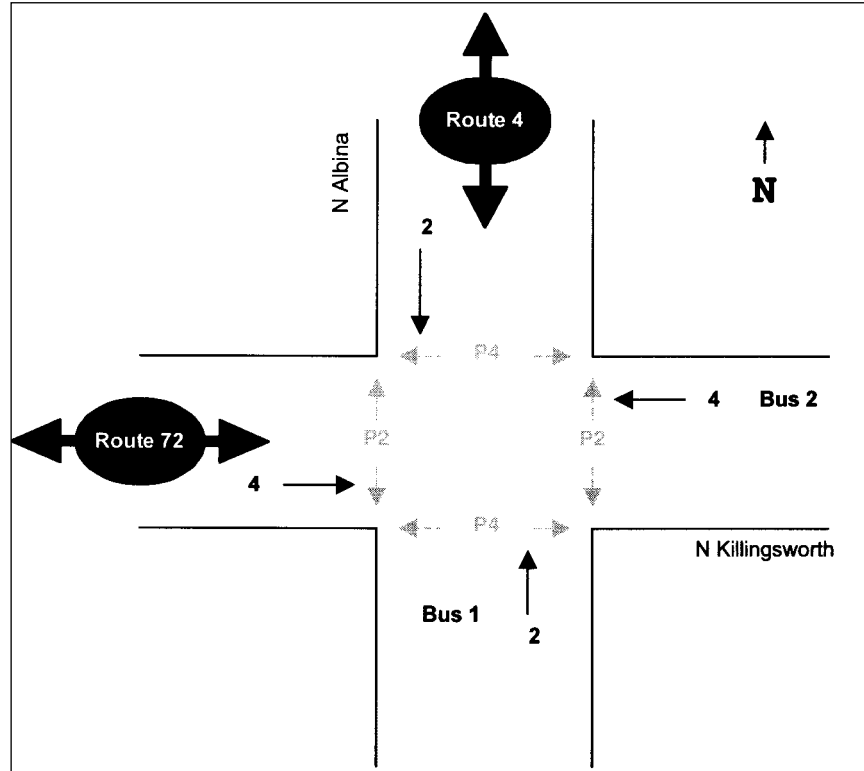

Figure 3. Case study intersection: N Albina/N Killingsworth

Coordinated Bus Phase Green Extension. In this case (Route 4 bus on phase 2), a call arrives during the green interval for phase 2. The limitation for green extension is determined by the minimum times for the phase 4 WALK, FLASH DON'T WALK (FDW), Yellow and All Red clearance intervals (Y+AR), and the minimum WALK (typically 4 seconds) for phase 2. This assumes that the bus phase (phase 2) of the next cycle maintains the phase 2 yield point (start of FDW) for the next cycle after the bus call has arrived. This practice preserves the coordination with the adjacent signals.

Noncoordinated Bus Phase Green Extension. For the noncoordinated phase (bus on phase 4), the lengthen plan is similar to what was described above. In this case, the phase 2 forceoff (start of FDW) remains zero and the phase 4 Y+AR must be accommodated, followed by the minimum phase 2 WALK time.

In either of these cases, it is desirable to set the range to a distance equal to the travel time associated with the extension time available. This approach limits the amount of unutilized priority provided and ensures that once a call is received and an extension plan is initiated the bus will pass through the intersection during the current cycle.

Red Truncation Plans Distance Setting

Red truncation is activated when a call is received on a phase that is not green. Red truncation reduces the length of the other (nonbus) phases to return to the bus phase earlier. In this scenario, the forceoffs for all phases change from their normal value. The worst case under the shorten plan is a received call that does not allow a truncation. Truncation is limited by the amount of time required for the recalled phases (pedestrian and vehicle).

Coordinated Nonbus Phase Red Truncation. The nonbus phase is truncated to the new forceoff associated with the bus plan. Truncating the nonbus phase allows an earlier return to the bus phase. In a two-phase intersection, the shorten plan is limited by the minimum times for the WALK, FDW, and Y+AR. The truncation benefit is provided in what normally would be a solid Don't WALK (DW) indication for phase 4. In some instances, WALK timing for phase 4 was reduced to provide more flexibility for the buses.

Noncoordinated Bus Phase Red Truncation. The City's signal timing policy maximizes the WALK portion of the coordinated phase. For this reason, the red truncation plan requires a forceoff that truncates the WALK portion and initiates the FDW before its normal forceoff. In this case, the truncation value should be set to reduce the WALK to an amount that allows the early return to the non-coordinated phase (phase 4).

In either case, it is desirable to set the range to a distance greater than the coordinated phase FDW value, so that the bus can be detected with adequate time for the controller to react. Provided that the proper sight distance exists and the bus stop spacing allows, the green extension and red truncation plans can be developed so that a bus will not stop at a traffic signal under off-peak traffic conditions.

Operational Issues of Bus Arrival

The arrival of the bus at the traffic signal is dependent on the speed at which the vehicle is traveling, the impedance it experiences, and the stops that it makes. These three factors may reduce the range at which it is desirable to place a low priority call to the controller. As discussed, providing priority to the bus phase prematurely may not only delay the bus, but it also may reduce the effectiveness of the traffic signal in its capacity to serve nonbus phase traffic. Each of these factors was examined to identify operational results associated with the arrival of the bus at the intersection.

Bus Travel Speed

To set the detection range, the assumed travel speed for the bus was set to equal the speed limit. In some cases, where the speed limit was greater than the expected speed, a lower value was used. A lower value was also considered in areas of denser development, where on-street parking, increased pedestrian activity, and numerous access driveways can slow the average speed of buses.

Bus Impedance

The impedance the bus experiences en route to the bus stop could result from pedestrians, cyclists, or parked vehicles. Bus impedance was incorporated into the travel speed where possible. Field studies during implementation may provide more insight as to the modifications necessary to accommodate special situations.

Stop Location

Nearside bus stops have been the subject of considerable debate. Nearside stops have the potential to render a call useless due to bus boarding and alighting in advance of the traffic signal. The initial operating concept was to set the range of the emitter at a distance 40 feet past the upstream bus stop (between the bus stop and the next traffic signal). This would eliminate the potential of a bus requesting priority and then stopping upstream, thereby eliminating the need for the priority.

Field tests of the Opticom emitter determined that in several locations this approach limits the range to less than 300 feet, reducing the overall effectiveness of the system. The potential limitation suggests more careful review of the bus stop location, possibly relocating it to the far side of the intersection.

When a bus places a priority call and has to stop upstream of the intersection, the call may be inappropriate. This occurs frequently because bus stop spacing standards place stops every two blocks (300 to 700 feet upstream of the traffic signal) in many areas throughout the City. To increase the effectiveness of the priority system, the rules were created for the range setting:

(The range will be set to maximize detection time in advance of the traffic signal, provided the following rules are followed. The smallest value from these three rules will be used to set the range for the detector.)

- Rule 1—Extension Time Distance: The allowable range calculation will be based on the extension time available in the controller. The speed limit will be used to convert the extension time to an appropriate distance. Truncation time should not be the criterion, since the benefit of the truncation suggests additional green time following the truncation should allow bus passage.
- Rule 2—Bus Stop Distance: The range should be 40 feet downstream of the bus stop closest to the traffic signal (disregarding nearside stops).
- Rule 2A—Modification to Bus Stop Distance: The first upstream bus stop will be disregarded if it is within 400 feet of the traffic signal and calculations per Rule 1 provide a distance greater than 900 feet. In this case, the distance of the second upstream bus stop will be used for comparison with the extension time distance.
- Rule 2B—Stop Utilization Modification: Tri-Met's AVL data will be reviewed to determine the percentage of buses that stop at the upstream bus stop. If this number is greater than half, Rule 2 will be followed.
- Rule 3—Traffic Signal Distance: The distance to the nearest upstream traffic signal will be noted to eliminate the potential of a priority call being received simultaneously at two signals, as this may lead to ineffective calls.

Rule 2A was created to reduce the limitation of closely-spaced bus stops on the priority corridors. At many of the intersections on the Fessenden and Division routes, the Extension Time Distance exceeds the Bus Stop Distance. To reduce the effect of Rule 2 at locations where the first upstream stop is seldom used, Rule

2A was created. In cases where Rule 2 is overly restrictive, the second upstream stop will be used as the criteria to compare the extension distance. The logic behind this decision was that the controller could recover from a call that is lost at an upstream stop, but it is less desirable to have two interruptions in the normal system resulting in poor responsiveness when the bus arrives at the traffic signal.

Ideally, information regarding stop frequency would be used to determine whether the bus stop upstream of the traffic signal should be considered. In this initial implementation, no data have been provided and thus only anecdotal observations will be used to determine whether the bus stops may be disregarded.

Results

The bus priority system has been implemented at 58 of the 72 intersections on Routes 4 and 104. For evaluation of the bus operation, Tri-Met's AVL system has been used to record the results for the implementation. Each route has been cut into segments to delineate the effects at each traffic signal. The segments vary from 800 to 2,500 feet and include up to three signals. Tri-Met's AVL system records many different pieces of data about every time any bus passes by a bus stop. The system records arrival time near a segment to initialize the start of the segment time and segment end time to identify the total travel time for each segment.

Early results have shown that improvements in travel time typically range from 5 to 8 percent of the overall travel time. On certain segments, the travel time reduction increases to as much as 24 percent of the travel time, but the value is highly dependent on several factors such as the length and the number of traffic signals within the segment.

Bus Priority Distance Setting Example: Northeast 33rd/Sandy

To illustrate the various points made above, we have chosen the Northeast 33rd/Sandy intersection to provide some additional context related to the priority distance setting. This example presents a summary of the application and constraints of the experience using actual headway and detection range values.

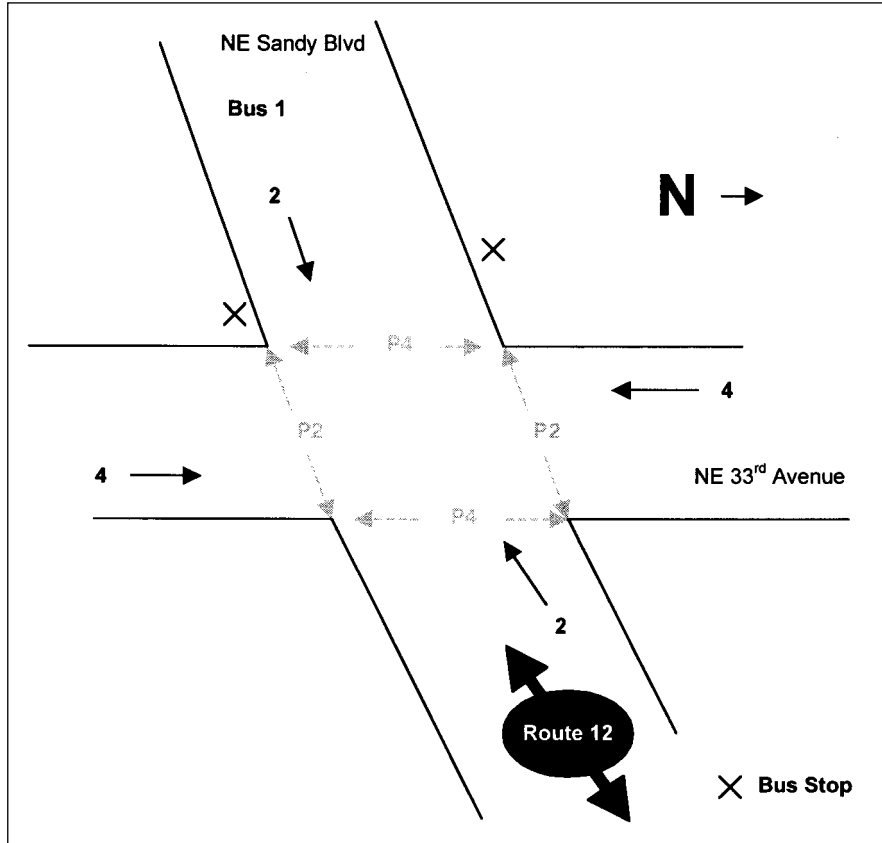

Figure 4. NE 33rd/Sandy intersection

Intersection Characteristics

This particular intersection was chosen as an example because it features both a nearside (inbound direction) and a farside (outbound direction) bus stop as shown in Figure 4. The Sandy Route 12 travels on the Northeast Sandy Boulevard corridor operating at 10-minute headways during peak periods. The speed limit in this vicinity is 30 mph.

Bus Travel Speed

On Sandy Boulevard, the assumed travel speed for the bus was set lower than the speed limit because of the nature of the corridor in this area. As shown in Figures 5 and 6, bus ridership and short stop spacing along this corridor result in low average speeds. Based on field observations, 15 mph was used.



**Figure 5. Farside stop at NE 33rd/Sandy
(outbound direction)**



**Figure 6. Nearside stop at NE 33rd/Sandy
(inbound direction)**

- Rule 1—Extension Time Distance: The allowable range calculation is based on the extension time available in the controller. This intersection is a simple two-phase intersection operating on a 100-second cycle during peak periods and, therefore, is not limited by the extension plan because approximately 30 seconds can be lengthened for the bus phase. Using 15 mph (22 feet per second) as the travel speed yields 660 feet for Sandy Boulevard. For the approach with the nearside stop, ridership would be evaluated to determine limitations to the extension time.
- Rule 2—Bus Stop Distance: The range should be 40 feet downstream of the bus stop closest to the traffic signal (disregarding nearside stops). For the outbound direction (farside stop), the distance was set based on this rule because Rule 1 was not a limiting factor.
- Rule 2A—Modification to Bus Stop Distance (40 feet downstream of second stop): In the case of the inbound route, the nearside stop significantly limits the priority distance that can be set. Using the second stop would yield a distance of 445 feet.
- Rule 2B—Stop Utilization Modification: Review of bus ridership data showed that the bus stops on 58 percent of the runs pass this intersection during the P.M. peak hour. For this reason, it was assumed the bus would stop at the nearside location and the distance was set to 40 feet downstream of the stop.
- Rule 3—Traffic Signal Distance: The distance to the nearest upstream traffic signal is not a factor at this intersection.

Table 3 summarizes the case study example in a tabular format.

Conclusions

Signal priority offers the promise to improve schedule reliability and reduce travel time through traffic signals. However, the complexities of bus operations suggest that more sophisticated decision logic will be necessary to achieve all the benefits of signal priority. The use of the AVL system in conjunction with the signal priority reduces the number of requests to the traffic signal, thereby reducing the effectiveness of the system, and requires an iterative approach to scheduling.

Table 3		
NE Sandy/33rd Avenue Intersection Tri-Met Route 12		
<i>Rule 1</i>		
	<i>Extension Time (ft)</i>	<i>Distance Between Stops (ft)</i>
Inbound (nearside)	660	485
Outbound	660	676
<i>Rule 2</i>		
	<i>Distance from Signal of Unstream Stp (ft)</i>	<i>Stop Utilization</i>
Inbound (nearside)	109	58%
Outbound	549	69%
<i>Rule 3</i>		
	<i>Distance Between Signal and Upstream Signal (ft)</i>	<i>Critical Critical Distance (ft)</i>
Inbound (nearside)	1,718	69
Outbound	1,928	549

AVL also promises to make the use of the emitter more selective depending on the status of the bus and boarding and alighting passengers. Further, measures supportive of signal priority such as the relocation of bus stops to the far side of each signalized intersection and the provision of stops at a distance upstream that increases the allowable range for the detection system.

Acknowledgements

The authors extend thanks to fellow staff from the City of Portland, Kittelson & Associates, Inc., and Tri-Met who in working on the project have made this implementation an enjoyable undertaking.

References

Kloos, W. C., and K. Turner. 1999. Implementing traffic signal priority for buses. *Compendium of Technical Papers*. Institute of Transportation Engineers.

Kloos, W. C., A. R. Danaher, and K. M. Hunter-Zaworski. 1994. Bus priority at traffic signals in Portland: The Powell Boulevard pilot project. *Compendium of Technical Papers*. Institute of Transportation Engineers: 420–424.

Parsons Brinkerhoff, Batelle. 2001. Tri-Met 5-year Intelligent Transportation Systems plan. *Final Report*. Portland, Oregon.

About the Authors

PETER KOONCE (pkoonce@kittelson.com) is an engineer with Kittelson & Associates and is based out of the Portland, Oregon, office. Mr. Koonce holds an undergraduate degree from Oregon State University and a Master of Science from Texas A&M University. He is a registered Professional Engineer in the State of Oregon.

TOM URBANIK (turbanik@utk.edu) is a professor and Chair of Excellence in Transportation at the University of Tennessee in Knoxville. Dr. Urbanik received a Ph.D. from Texas A&M University, Master of Science in civil engineering from Purdue University, Bachelor of Science in civil engineering from Syracuse University, and a Bachelor of Science in forest engineering from the New York State College of Environmental Science and Forestry. He is a registered engineer in Michigan and Texas.

BILL KLOOS (Bill.Kloos@trans.ci.portland.or.us) is the signal system manager for the City of Portland, Oregon. In that capacity, he manages the Traffic Signals/Street Lighting/ITS Division responsible for the planning, design, construction, operation, and maintenance of nearly all the traffic signals and streetlights within Portland. Mr. Kloos is a graduate of Montana State University.

WILLIE ROTICH (Willie.Rotich@trans.ci.portland.or.us) is the ITS engineer for the City of Portland. Mr. Rotich was the project manager for the City of Portland on the Transit Signal Priority project. He is a graduate of Oregon State University.

JOHN RINGERT (jringert@kittelson.com) is the consultant team project manager for Kittelson & Associates. He has more than 11 years experience in traffic design, traffic engineering, and planning. Mr. Ringert received a Bachelor of Science degree from the University of Idaho and received a Master of Science degree from Texas A&M University.

Door-to-Door Mobility: Evaluating a Bus Rapid Transit Community Transport Concept

Matthew Pahs, Minnesota Department of Transportation

Mark Rohden, Tri-Met

David Hampsten, City of Portland, Oregon Department of Transportation

Seth Gallant, Paratransit Services

Robert L. Bertini, Portland State University

Abstract

Portland, Oregon's regional government, Metro, has designated specific communities in outer Southeast Portland as areas that should be planned to accommodate future population growth. Both Metro and the Tri-County Metropolitan Transportation District of Oregon (Tri-Met) have expressed a desire for Bus Rapid Transit (BRT) service to this area from downtown Portland, within a corridor approximately following Southeast Powell Boulevard and Foster Road.

A preliminary analysis of BRT alignment alternatives was completed for this study. After six possible alignment options linking downtown Portland with Pleasant Valley and Damascus Town Centers were identified, a multivariate corridor analysis was applied to each option. Criteria used to select the best alignment alternative included regional connectivity, local ridership, operational costs, trip duration, distance, right-of-way and political feasibility, environmental costs, and capital costs. In addition, recommendations have been made for possible station locations along the preferred alternative corridor.

This analysis is intended to assist Tri-Met in its efforts to begin planning, designing, and implementing a BRT system in this area. The results of the analysis suggest that

a BRT system is feasible for the Powell/Interstate 205/Foster alignment. The outcome also suggests that BRT has the capacity to influence land use and could generate high transit ridership. Overall, it is recommended that Tri-Met and Metro continue to evaluate opportunities for BRT in this alignment.

Introduction

For many people, buses have become a last resort transportation choice due to their apparent reputation as an undesirable, poorly performing mode. However, as traffic congestion increases and light rail transit (LRT) construction costs escalate, many transit properties have begun to take advantage of technological advances and new concepts in vehicle design and corridor development.

BRT combines qualities of fixed-guideway transit with the flexibility of traditional bus systems. A BRT system can use both general traffic lanes and/or dedicated guideways, smooth-riding vehicles, improved station amenities, and Intelligent Transportation Systems (ITS) technology to enhance the performance of the system and encourage higher transit usage. By combining attributes of rail and bus systems, BRT can achieve the benefits of both. The purpose of this corridor analysis is to evaluate and prioritize BRT elements that are responsive to community needs and the expected travel demand in Portland, Oregon's Southeast corridor.

Purpose and Need

The Portland region is delimited by an urban growth boundary (UGB), which designates urban and rural lands. Metro has projected Southeast Portland as one area for growth (see Figure 1). In particular, the communities of Pleasant Valley and Damascus are projected to grow in population from 13,000 to 125,000 residents by 2020 (Metro 2000). Infrastructure is currently lacking and transit service does not exist in these areas. Metro's Regional Transportation Plan (RTP) has identified several potential BRT corridors for future study and development, including the Powell–Foster corridor extending from Portland's downtown to Pleasant Valley and Damascus. Consistent with regional planning policies, it is likely that development will be concentrated in town centers and along major transportation routes. Implementing a BRT system in this corridor would anticipate growth and demand for travel to downtown Portland, build a

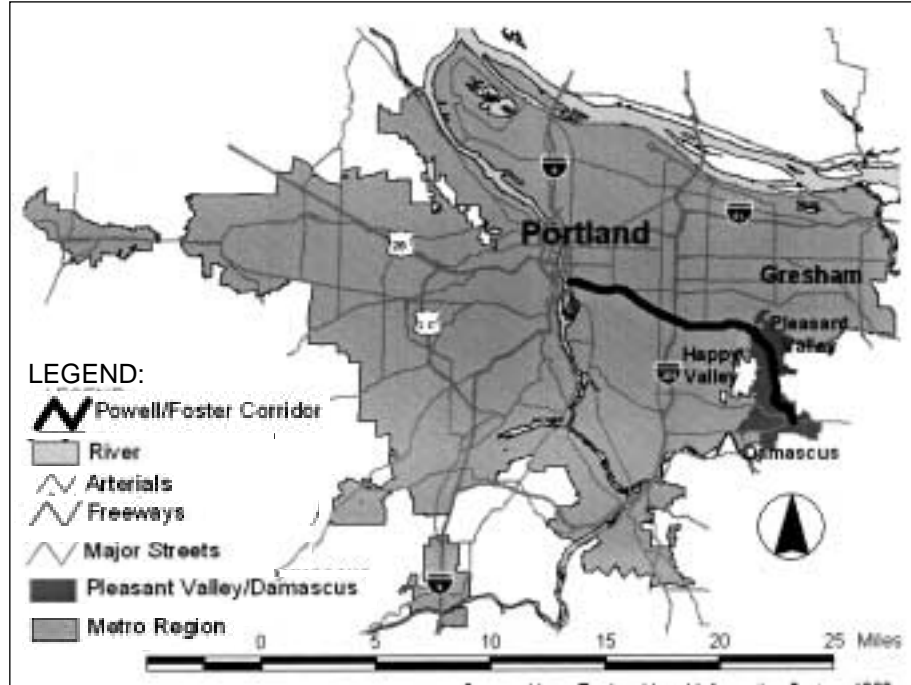

Source: Metro Regional Land Information System. 1999.

Figure 1. Regional context

transit constituency, and provide an opportunity to proactively influence future growth and create transit-oriented communities (TOCs).

Door-to-Door Mobility Concept

The cumulative effects of traffic congestion, traffic signals, number of stops, and passenger boardings and alightings add to total transit travel time, affecting on-time performance and ridership. Buses typically travel in mixed traffic on established roadways and tend to lack visibility and attractiveness, constituency, and a sense of permanence in an urban setting. Portland Door-to-Door Mobility (PDM) will integrate visible amenities, such as high-capacity stations and articulated vehicles, to create a transit system that will attract new riders. Moreover, the concept will provide single-seat rides to downtown Portland and seamless transfers to the existing transit network.

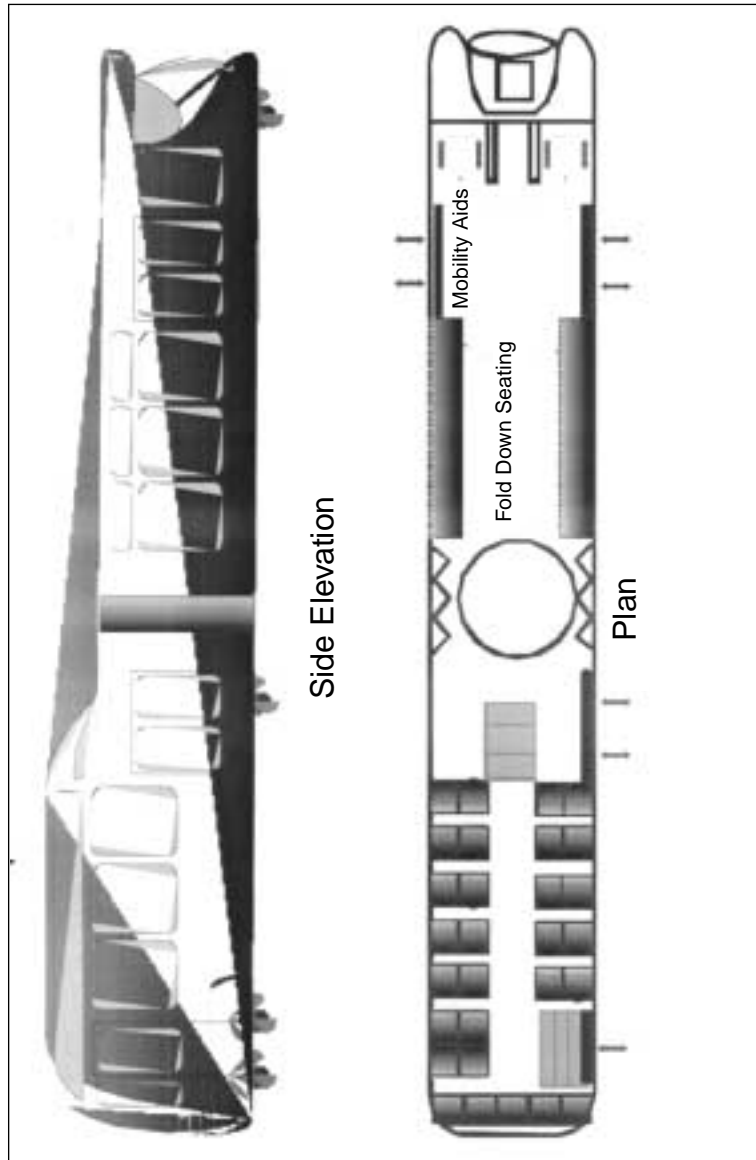

Figure 2. BRT vehicle concept

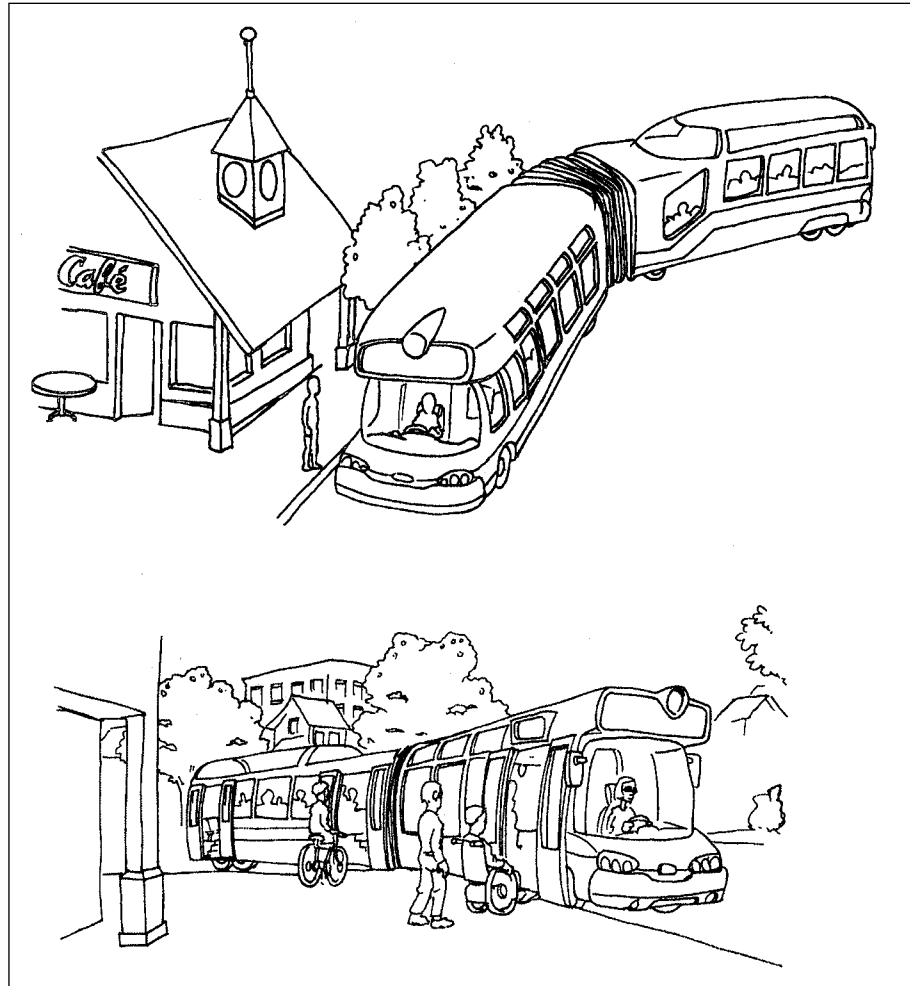

Figure 3. Vehicle concept

Innovative Vehicle Design

PDM vehicles (Figures 2 and 3) will promote a highly desirable form of transit and distinguish the system from the local bus service. Using an innovative design and bright colors, along with large windows and wide doors, the articulated vehicles will be attractive to both choice riders and potential new riders. Wide doors on both sides allow for simultaneous boarding and alighting, which will facilitate passenger movement and minimize dwell times. The vehicles' low-floor

design provides level boarding to all customers, including people using mobility aids. As shown in Figure 2, the seating arrangement includes forward- and rear-facing seats, individual foldout tables, and flip-down side-facing seats in the front section of the vehicle. Bicycles can be stored out of the way on wall or ceiling mounts. In addition, Americans with Disabilities Act (ADA) requirements will be met by accommodations for up to two wheelchair units in the front section of the vehicle.

Intelligent Transportation Systems

The PDM concept vehicle will be equipped with advanced voice and data communication technologies and an automatic vehicle location (AVL) system using Global Positioning Systems (GPS) for fleet management and for providing real-time information to all customers. A transit signal priority system will also use real-time vehicle information to predict vehicle arrival times, determine whether that vehicle is on schedule, and provide either an extension of the green phase or a truncation of the red phase.

Guideway

The PDM system will incorporate a guideway where possible, allowing the vehicle to travel safely at high speeds without increasing the width of the travel lanes. Guideways are permanent investments in infrastructure, providing a fixed route for the vehicles, which enables the system to influence land uses, encourage transit-oriented developments (TODs), and promote ridership. The guideway will also allow vehicles to arrive at stations with longitudinal and lateral precision, increasing the efficiency and safety for all patrons, particularly those who use mobility aids. Typical street cross sections for this BRT system are shown in Figure 4.

Propulsion System

The PDM concept vehicle has been developed with a propulsion system that employs emerging technologies including fuel cells and microturbines, for a fully regenerative hybrid engine (see Figure 5). The vehicle is powered by a natural gas-fueled, high-speed microturbine/generator. An in-wheel, inverter-controlled, three-phase axial-flux, permanent-magnet motor supplies power to the vehicle's wheels. Excess energy from the generator produces hydrogen from water in a

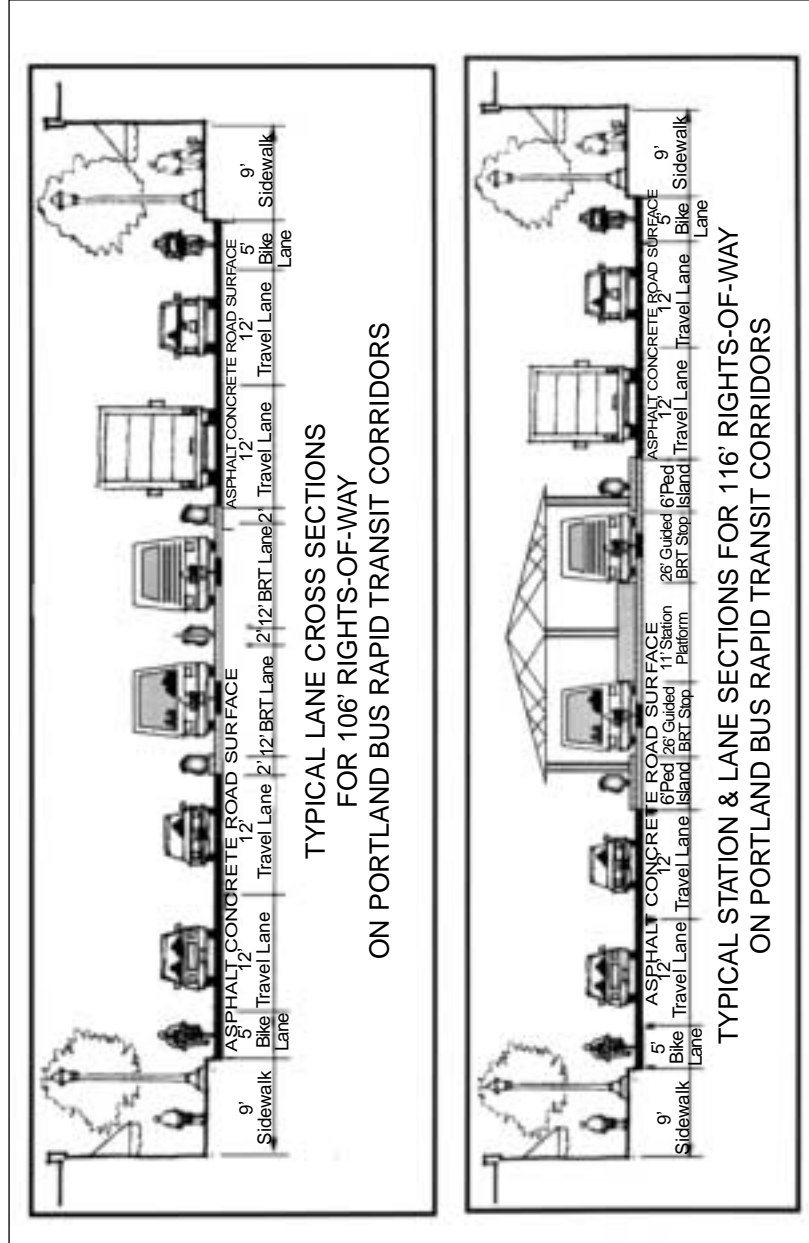

Source: Design by prhg consulting, 2001.

Figure 4. Cross sections

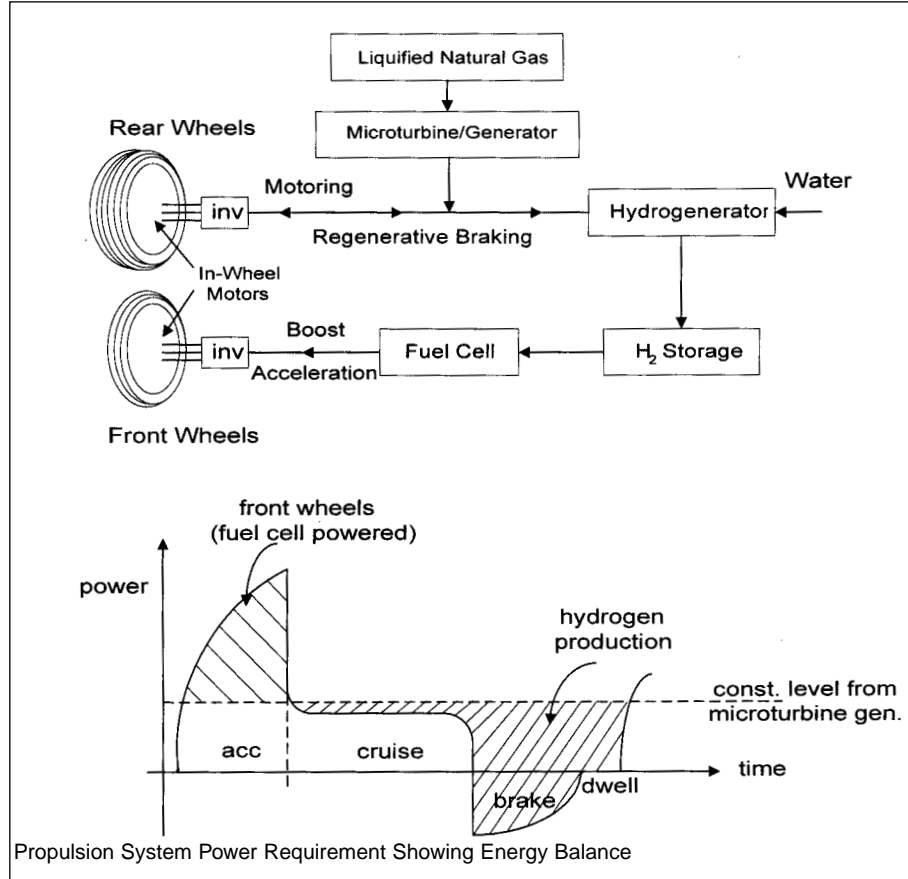

Figure 5. Sustainable propulsion system

hydrogenerator (advanced electrolysis process), which is stored for the fuel cell. Energy from the cell powers the front wheels to provide additional grade-climbing ability or boost acceleration as necessary. The vehicle's braking system is regenerative into the hydrogenerator to complete the process.

The propulsion system will be fueled by clean-burning, liquefied natural gas. This will be burned in a low-mass, high-speed microturbine operating at constant speed and power for maximum efficiency. During acceleration, all of the output of the microturbine generator will go to the rear wheels; the front wheels will be driven via power from the fuel cell. During cruise, there will be no power supplied to the front wheels. In this case, surplus energy from the microturbine generator

will be used to produce hydrogen by electrolysis. During deceleration, the braking effort of the rear wheels will increase the level of hydrogen production. Clean and quiet vehicles will establish a positive image for BRT and will set it apart from conventional city buses.

Accessibility and Mobility

The PDM approach to accessibility issues is comprehensive. People with disabilities will have two areas on the vehicle that will automatically secure them and their mobility aids (Figure 1). Standing passengers will be provided handles and seat rests on internal sections. Both the front and rear areas of the vehicle will be equipped with real-time passenger information systems, providing both audio and visual communications. Real-time information systems will interface with personal electronic devices (e.g., personal digital assistants, cellular phones) for commuters who wish to download a schedule or route map. The vehicle is also equipped to support personal wireless communication systems for those who need to access the Internet during their trip. Station platforms will match the vehicle's door level, making boarding trouble-free and efficient for all passengers. Platforms will also include shelters to protect passengers from the elements and include electronic kiosks providing schedule information. Kiosks will also house the fare system, which will allow passengers to prepay for their trip using a smart card to ease boarding and alighting.

Community BRT System

The PDM system will be integrated with Tri-Met's transit operations in the surrounding area and will also include its own neighborhood feeder service for underserved areas of the community. Stations will be developed as community assets, where amenities may include car sharing, neighborhood electric vehicles, or electric bicycle rentals, each of which will provide local connections for residents. Pedestrian and bicycle access to the PDM system will be a priority, as encouraging these two modes will have a positive impact on ridership. Stations will become neighborhood focal points, with opportunities for retail, package delivery, cafes, and community centers of all kinds.

BRT in Southeast Portland

Implementation of BRT in the Southeast Powell–Foster corridor poses several challenges. In some areas, existing arterials have insufficient cross sections

necessary for providing an exclusive right-of-way for BRT. In addition, general traffic flow must be maintained and local parking and air quality impacts must be minimized. BRT could help create livable TOCs and encourage transit ridership concurrent with the expected population growth in metropolitan Portland. Components of a BRT system in Southeast Portland would include some or all of the following:

- Exclusive guideway/lanes: A lane on an urban arterial reserved for the exclusive use of BRT.
- Transit signal priority: Extension of green time or actuation of signal upon detection of an approaching BRT vehicle.
- Traffic management improvements: Low-cost infrastructure elements to increase the speed and reliability of BRT service (e.g., signage, curb extensions).
- Faster boarding: Prepaid automatic fare collection systems at stations allow passengers to board easily and help facilitate quick boarding.
- Integration of transit development with land-use policy: BRT and compact TOD support one another, use less land, and encourage creation of neighborhood centers.
- Improved facilities and amenities: The advantages of separating BRT from traffic can be complemented with improved amenities such as shelters, stations, and real-time schedule data [Federal Transit Administration (FTA) 2000].

Analysis

This analysis is an adaptation of a process designed to elicit responses from stakeholders, whereby those individuals are asked to judge the importance of certain criteria in making transportation policy decisions. This corridor study includes the evaluation of six possible BRT alignments using a list of criteria and an initial study of potential station locations. In this case, the authors assessed the importance and value of the criteria.

Each alignment alternative originates in the transit mall in downtown Portland and terminates at the Pleasant Valley and Damascus Town Centers (Figure 1). According to the FTA, a BRT system should consider the following criteria:

1. transit travel-time savings and ridership increases;
2. impacts on open spaces, wetlands, and historic resources;
3. compatibility with land-use policies and contribution to economic development; and
4. the cost-effectiveness of the project (FTA 2000).

This study attempts to adhere to these considerations where applicable.

Alignment Options

The original alignment considered for this analysis was the Powell/Foster route to Damascus. The primary constraints associated with this particular option are two bottlenecks on Foster Road: one on Foster between 50th Avenue and Interstate 205; the second on Foster near 162nd Avenue and Jenne Road. These right-of-way constraints led to the consideration of five additional options (see Figure 6), including:

1. *Powell/Interstate 205/Foster option*: Avoids narrow section of Foster from 50th to Interstate 205; uses wide right-of-way on Powell between 50th and Interstate 205; then joins freeway, using dedicated lane, and heads south, rejoining Foster.
2. *McLoughlin/Sunnyside and McLoughlin/Highway 212 options*: Uses proposed South Corridor down McLoughlin Boulevard from downtown Portland to Clackamas Regional Center, avoiding the bottleneck on Foster Road at 162nd; proceeding along Sunnyside Road or Highway 212 to the Pleasant Valley/Damascus area. Several studies for this route are currently being assembled, most notably by Tri-Met and Clackamas County. However, no final decisions or funding for such projects has been forthcoming.

3. *Powell/Interstate 205/Sunnyside and Powell/Foster/Interstate 205/Sunnyside options:* Uses Interstate 205's generous right-of-way. The two alternatives using this general route are nearly identical except that the former follows Powell all the way to the freeway, while the latter leaves Powell at 50th and follows Foster to the freeway. Despite appearing indirect, these were chosen because they avoided environmentally sensitive areas in Pleasant Valley and because they connect to the Clackamas Regional Center.
4. *Powell/Division/182nd option:* Uses Powell until Interstate 205, heads briefly north on Interstate 205, and turns east on Division Street, with a very wide right-of-way to Gresham, turning south on 182nd to Pleasant Valley/Damascus.

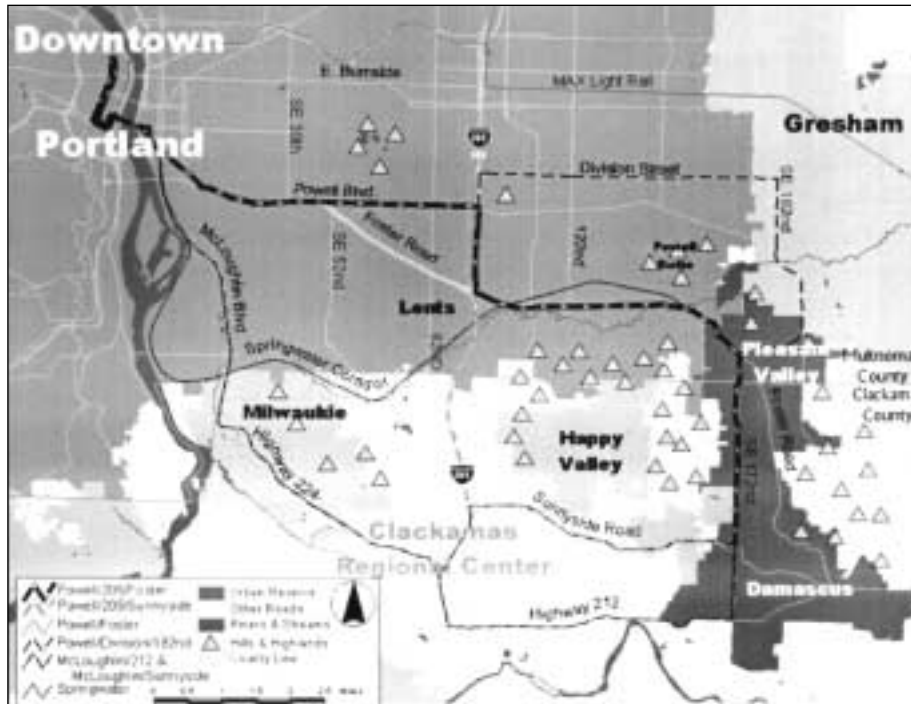

Figure 6. Alignment alternatives

5. *Springwater Corridor option*: Former railroad right-of-way (100 feet wide), now a recreational trail that joins with Foster Road near Lents Town Center. Despite potential opposition, the wide right-of-way may provide valuable comparison with other alignment alternatives.

Corridor Analysis

Several conditions were developed to assess the relative merits of each alignment, and each criterion was weighted based on its relative importance. The final score for each criterion was rated on a percentage scale and was weighted and totaled. An explanation of the criteria and their respective meanings follows.

Regional Connectivity (25% Weight)

The connectivity score was determined by estimating the presence and relative importance of activity centers and trip generators along each alignment. These included retail and employment centers, schools, colleges, and hospitals. Major activity centers were then located and geo-coded in a Geographic Information System (GIS). The trip-generation capacity of each activity node was qualitatively estimated based on empirical data and several interviews with transportation professionals. Node scores were then compiled and divided by the entire length of the route to generate a preliminary connectivity score for each corridor alignment.

Local Ridership (23% Weight)

To estimate current ridership on each corridor, the population for each segment was multiplied by corresponding ridership rates [determined by a spatial sampling of 1998 Census tract populations (Metro 2000) within one-quarter mile of each segment] divided by the total daily transit boardings. Ridership rates for remaining corridor segments were interpolated based on density and Euclidean distance from downtown Portland. Using Metro data projecting metropolitan growth rates from 1990 to 2010 (Gresham 1999), the projected 2020 population for each segment was estimated. The total local ridership score was calculated by compiling the respective ridership populations for all segments and dividing this total by the route mileage.

Operations (26% Weight)

This variable includes estimated travel time for each option, number of sharp turns the vehicle must make, number of stations, and approximate dwell

time at each station. This variable also includes operational costs, which are combined with travel time, because both are based on the length and directness of the corridor. Operational costs and travel time are functions of posted speed limits, length of each alignment, vehicle costs (assuming a 40-year lifespan), maintenance costs, and long-term labor costs. In addition, penalties were imposed on the routes, including:

- a reverse-direction travel penalty of 1.5 minutes for every 1 minute of indirect travel time;
- a sharp turn (>90 degrees) penalty of 15 seconds; and
- a deceleration, dwell, and acceleration penalty at each station of 1 minute to the overall time.

The operations score is based on the following formula:

$$\text{Total weighted score} = 10 / (T_t / T_{ts})$$

where:

T_t is route total time = $(T - T_s)^2 + T_u + H + (S \times D)$.

T_{ts} is shortest route total time.

T is route time = $\sum (D \times R)$.

T_s is shortest route time.

D is route segment distance.

R is segment speed limit.

T_u is 90-degree turn time penalty.

H is reverse-direction time penalty.

S is station time penalty.

The authors used the $(T - T_s)^2$ statement to account for the growth in maintenance costs as a route length increases from the shortest possible route.

Each corridor option was given a trip-time score, including actual minutes and penalty minutes for reverse-direction travel and sharp turns. The operations score was generated by compiling the respective time distances for all routes, and then rating the result on a percentage scale.

Right-of-Way Costs (14% Weight)

Right-of-way includes roadway, sidewalks, and generally all land between the sidewalk and property line. For this BRT system, the ideal right-of-way (106 feet) would include a 9-foot sidewalk with street trees, a 5-foot bike lane, two 12-foot auto travel lanes, and a 12-foot BRT lane with 2-foot buffers (Figure 4). To find the right-of-way score, a 106-foot right-of-way was assumed for all the routes, with the exception of the Springwater route. The scores represent the costs of purchasing land or obtaining easements from property owners to expand the right-of-way and the political cost, which includes consideration of:

- resistance to growth, development, and loss of urban or rural aesthetics;
- resistance to building demolition, specifically historic or community structures and parks;
- need to maintain existing auto- and bicycle-lane capacity and sidewalks; and
- need to minimize negative changes to traffic patterns.

The right-of-way score was calculated by compiling the qualitatively estimated costs of land and political feasibility for the routes, then rating the result on a percentage scale.

Environmental Impacts (Weight 8%)

This criterion refers to the natural environment (creeks and wetlands in the Pleasant Valley/Damascus area, and hillside cuts on Foster), and also to pedestrian safety mitigation measures. The chosen corridor should enable any negative impacts on either one to be mitigated at a relatively affordable cost. As there is little variation in negative pedestrian impacts among these corridor options, and the environmentally-sensitive areas are located in only a few places, it was determined that this criterion did not require substantial weighting. The environmental score was calculated by qualitatively estimating the costs of environmental and pedestrian mitigation for the routes. For each alignment, the analysis qualitatively assessed:

- possible harm to the natural environment that must be mitigated;
- estimated mitigation costs; and

- methods for minimizing negative impacts to the pedestrian environment (e.g., providing wide sidewalks, good signing, striping and lighting, pedestrian refuge islands at crossings, and attractive and safe system access).

Construction Costs (Weight 4%)

Infrastructure costs include roadway reconstruction (earthwork, paving, and striping), drainage, sidewalks, stations, signals, lighting, ITS enhancements, guideway if used, BRT lane pavement, and landscaping. Costs associated with acquiring land for right-of-way expansion are not included.

Results

In an analysis of six routes within the study corridor, the Powell/Interstate 205/Foster alignment was the best alternative, with a final score of 82 percent of the maximum weighted score of 100%. (Table 1 summarizes the overall results of the multivariate analysis.) This route, which is 15.8 miles in length, will serve the Transit Mall and Union Station in downtown Portland and cross the Willamette River on the Hawthorne Bridge. The route travels east on Powell Boulevard to Interstate 205, where it travels south to Foster Road within the Interstate corridor, and continues on Foster Road to the future Damascus Town Center. It is a relatively direct route to the Pleasant Valley/Damascus area and traverses dense population areas and activity centers where ridership would be strong.

Overall, the Powell/Interstate 205/Foster alignment was judged to be superior in this analysis because of its directness and connectivity to regional and employment centers. Residential densities along Powell Boulevard provide adequate ridership for current bus routes that use this arterial, and projected population will further increase ridership. This route's connections to activity centers are better than those of the Powell/Foster alternative, and its use of a portion of the Interstate 205 right-of-way will allow the system to be more rapid. Its route along Powell will have a wide right-of-way and will not be constrained by the densely built-up areas on Foster Road between Southeast 50th and Interstate 205.

Because of its advantages in right-of-way width, construction and acquisition costs will be somewhat minimized. For example, Interstate 205 was originally constructed to accommodate a busway and includes a tunnel that crosses under from the northbound lanes to the southbound lanes, suggesting

that a high-capacity transit system was intended here. Due to future population and employment growth in the area, Foster Road likely will need to be expanded to create access for residents. The entrance to Pleasant Valley is hindered by a natural bottleneck in the surrounding topography, located at the intersection of Southeast Foster and Jenne Road. Negative environmental impacts could potentially occur at this location, as well as further into the valley itself.

Station Analysis

Optimal locations for future BRT stations were analyzed based on the following criteria:

- **Speed:** Stations should be located near large intersections where speed will be reduced and should be at least one mile apart.
- **Right-of-way:** Accommodate station platform while maintaining existing infrastructure.
- **Environmental and Pedestrian:** Must allow for safe and convenient boarding.
- **Ridership:** Near intersections of major arterials and major transit corridors.
- **Land Use:** Near high-density, mixed-use areas; conducive to transit-oriented redevelopment; outer stations should accommodate park-and-ride facilities.
- **Connectivity:** Near government and educational institutions; supported by adequate commercial development; access to employment and industrial uses.

Based on the station analysis criteria, optimal station locations were determined for the highest scoring alignment. Table 2 shows the rating scale used for the Powell/Interstate 205/Foster Road alignment stations.

Conclusions

While the mean score for all six alternatives examined was 73.5 percent, the Powell/Interstate 205/Foster alignment scored 82 percent since it includes a direct route with good local ridership potential. Although the Powell/Interstate

Table 1
Alignment Analysis Results

<i>Southeast Portland Bus Rapid Transit Alignment Options</i>	<i>Connectivity (%)</i>	<i>Ridership (%)</i>	<i>Operations (%)</i>	<i>Right-of-Way (%)</i>	<i>Environment (%)</i>	<i>Construction (%)</i>	<i>Total Score (%)</i>
Powell/205/Foster	68	84	93	83	82	82	82
Powell/205/Sunnyside	100	77	53	92	92	94	80
Powell/Foster	46	88	100	60	90	83	77
Powell/205/Division/182nd	67	100	44	94	100%	92	75
Powell/Foster/205/Sunnyside	84	79	54	73	98	96	76
South Corridor/212	91	44	57	100	86	100	73
South Corridor/Sunnyside	84	48	60	89	91	89	71
Springwater Corridor	38	58	60	68	35	77	54
Maximum Possible Score	100	100	100	100	100%	100%	100

Table 1(continued)

Raw Scores	Connectivity (%)	Ridership (%)	Operations (%)	Right-of-Way (%)	Environment (%)	Construction (%)	Total Scores (%)
Powell/205/Foster	170.0	193.2	241.8	116.2	65.6	32.8	819.6
Powell/205/Sunnyside	250.0	177.1	137.8	128.8	73.6	37.6	804.9
Powell/Foster	115.0	202.4	260.0	84.0	72.0	33.2	766.6
Powell/205/Division/182nd	167.5	230.0	114.4	131.6	80.0	36.8	760.3
Powell/Foster/205/Sunnyside	210.0	181.7	140.4	102.2	78.4	38.4	751.1
South Corridor/212	227.5	101.2	148.2	140.0	68.8	40.0	725.7
South Corridor/Sunnyside	210.0	110.4	156.0	124.6	72.8	35.6	709.4
Springwater Corridor	95.0	133.4	156.0	95.2	28.0	30.8	538.4
Maximum Possible Score	250.0	230.0	260.0	140.0	80.0	40.0	1000.0

All corridors begin in Downtown Portland and end in Pleasant Valley/Damascus.
 All totals are raw scores out of a possible 1,000.

Table 2 Station Area Analysis											
Station Location	At Intersection/ Spacing	Right-of-Way	Safe/Convenient Boarding	Near Major Arterials	Near Major Transit Lines	High Density/ Mixed Use	Transit Oriented Development	Park and Ride	Institutions & Education	Commercial Connectivity	Employment & Industrial
Station Location	Environmental/ Speed	Right-of-Way	Pedestrian	Ridership	Ridership	Land Use	Land Use	Land Use	Commercial Connectivity	Employment & Industrial	
Downtown Portland	-	+	+++	+++	+++	+++	+++	n/a	+++	+++	+++
OMSI/Eastside Industrial	+	++	++	+++	+++	+	++	n/a	++	-	+++
11th/12th & Division/Clinton	+	++	++	+++	+++	+	++	n/a	+++	+	+++
26th & Powell	+	-	++	+++	+++	++	++	n/a	+++	+	+++
39th & Powell	+	-	+	+++	+++	++	++	n/a	-	++	-
50th/52nd & Powell	+	++	+	+++	+++	++	++	n/a	-	++	-
68th & Powell	++	++	++	+++	+++	++	+	+	++	-	-
82nd & Powell	-	+	-	+++	+++	++	+	+++	-	+++	-
I-205 & Powell	++	+++	-	+++	+++	-	++	+++	+++	+	-
I-205 & Foster	++	+++	-	+++	+++	++	++	+++	-	++	++
122nd & Foster	++	++	-	+++	+++	++	-	+++	-	+	-
136th & Foster	+	-	++	+	--	-	-	++	-	-	-
172nd & Foster	+	+	+	+++	-	++	++	++	+	++	-
172nd & Sager	++	+	+	+	-	-	++	+++	-	-	-
172nd & Hagen	++	+	+	+	-	-	++	+++	-	-	-
172nd & Sunnyside	+	++	++	+++	++	++	++	+	+	++	-

205/Foster alignment did not score the highest on any single criterion, it did score very well on most. Expanding Southeast Foster Road at 162nd and Jenne Road to four travel lanes will be very expensive due to high costs of either cutting into the steep hillside to widen Foster or tunneling underneath the ridge. Though plans to widen Foster at this section are presented in Metro's RTP, the additional costs of widening this by two additional lanes for BRT are potentially prohibitive. The lowest score for this alignment was 68 percent for connectivity. Although it is a short and direct route and has a high ridership score, there is not as high a number of commercial centers and other activity locations as the second best option, Powell/Interstate 205/Sunnyside.

Model Limitations

The model used for this analysis is not without its limitations. The connectivity and ridership variables together made up nearly half of the combined weight of the six criteria. A sensitivity analysis that included varying the weights for these criteria would likely result in a different final score for the Powell/Interstate 205/Sunnyside corridor, for example. Given that this was a preliminary analysis, only basic ridership statistics were included, and only projected ridership of those living within a quarter mile of the corridor was considered. The analysis did not include the influence of feeder bus routes bringing riders to the BRT corridor (though feeder service would be paramount to the success of this system); park-and-ride lots, which can have an extensive coverage area; and riders who walk or bike to a BRT station from more than a quarter mile away.

Recommendations

A fully implemented BRT system should include frequent service, with a maximum of 30-minute headways, and 10- to 15-minute headways during peak hours. The system should have a full-service day, from early morning commutes to late night service. Vehicles should be articulated and designed for level boarding to allow for easy accessibility for all passengers, including those who require extra time to board, such as the elderly, people with disabilities, and users with sight impairments. Wide doors should be included on both sides of the vehicle to allow quick and obstacle-free access. Vehicles and station platforms should have real-time audio and visual information systems to alert

passengers of departure and arrival times. Stations should be fully enclosed where possible, to act as a shield from both inclement weather and general traffic impacts. Stations should be equipped with amenities such as preboard payment machines, real-time bus information, benches, and trash receptacles.

Implementation Strategy

The Powell/Interstate 205/Foster PDM system should be built incrementally. Since BRT utilizes existing roadways, it can be implemented initially with minor improvements, and then other infrastructure can be added as demand increases and funding becomes available. A fleet of articulated vehicles that are distinct from other vehicles in the system should be purchased for the BRT line to give it its own identity prototype vehicle design is shown in Figures 2 and 3). Ultimately, vehicles would closely resemble those currently manufactured by Civis. Stations should be constructed in sections where median BRT lanes are added. The first sections of dedicated lanes will most likely be built in the middle of the route, around Powell and Interstate 205. Outer segments will be developed in the future, as demand increases in those areas and roadway capacity increases. The innermost sections are relatively dense and present additional physical challenges, such as negotiating with railroads to share right-of-way; which Willamette River bridge it will use; and the obvious need to acquire property to provide adequate right-of-way for the system. In the meantime, even a separated, dedicated lane from Southeast 50th and Powell to Southeast 122nd and Foster could dramatically reduce travel time in this corridor.

Ideally, there would be a complete system of dedicated median BRT lanes from the Hawthorne Bridge to Damascus Town Center by 2020. Due to right-of-way limitations, the completed infrastructure may necessitate single-lane operation or operation in mixed-traffic lanes in limited sections. These include sections of Powell where there are parks or buildings at the edge of the right-of-way, and on Foster at the 162nd Avenue bottleneck.

Despite these limitations, a rapid, compelling, limited-stop BRT service can be implemented in this corridor that would be competitive with peak-hour automobile trips, as well as a pleasant way to travel around the region. Installing a guidance system, in addition to using dedicated lanes, can further enhance the

service by making it more convenient and attractive to potential riders. The combination of these amenities holds great promise for improving transit service and making it an appealing alternative to the automobile at a very affordable cost.

Acknowledgements

Our study team was assisted by Professors Kate Hunter-Zaworski, Annette Von Jouanne, and Alan Wallace of Oregon State University; Professor James Strathman of Portland State University; Adrian Wallace of the Portland Art Institute; and Graham Carey of Lane Transit District. Conrad Wagner and Dan Sturges provided valuable feedback. Alan Lehto of Tri-Met was our project client. The advisory team was comprised of Tom Kloster and Kim White of Metro. The Planning Workshop Faculty included Deborah Howe, Connie Ozawa, and Tom Sanchez of Portland State University.

Some of the ideas and images contained in this article were submitted as part of an entry for the Bus Rapid Transit and the American Community National Planning and Design Competition sponsored by WestStart and the Federal Transit Administration. We would like to thank Fred Silver of WestStart for his support and encouragement.

References

- Briggs, Kara. April 14, 1999. Urban creek holds good news: Salmon. *The Oregonian*.
- Clackamas County Long Range Planning, Department of Transportation and Development. November, 2000. *Damascus concept planning study*.
- Federal Transit Administration (FTA) Office of Research, Demonstration and Innovation. 2000. *Issues in bus-rapid transit*.
- Giannopoulos, G. 1989. *Bus planning and operation in urban areas: A practical guide*.
- Gilmore Research Group. November 2000. *Tri-Met attitude and awareness survey*.
- Golias, Ronan. May/June 1997. Between bus and tramway. UTI: 31–34.
- Gresham, City of, Long Range Planning Team. 1999. *Current socioeconomic trends in the City of Gresham*: 1.

Haywood, Howard M. October 1999. Massachusetts *Bay Transportation Authority Bus-Rapid Transit Silver Line*.

Henke, Cliff. January/February 1998. Cities eye busways—again. *Metro Magazine*: 35-40.

Lane Transit District. 1999. *Lane Transit District pilot East-West Bus-Rapid Transit corridor*.

Lane Transit District. November, 2000. *Lane Transit District Bus-Rapid Transit, Draft Environmental Assessment*.

Metro. July 1994. *Region 2040, Decisions for tomorrow, transportation analysis of the growth concept*.

Metro. 2000. *Regional land information system (RLIS)*. Portland, Oregon.

Mortenson, Eric. February 8, 2001. Sides gather together to shape new Pleasant Valley. *The Oregonian*.

Patton, Carl V. et al. 1993. *Basic methods of policy analysis and planning*. Englewood Cliffs, NJ: Prentice Hall.

Pleasant Valley Concept Plan. March/April 2001. *Public Comment Report, Community Forums 1 & 2*.

Reed, Earl. March 2001. Portland Office of Transportation (informal interview).

Scannell, Ed. May 12, 2000. Los Angeles takes first step toward Bus-Rapid Transit. *The Urban Transportation Monitor*: 1.

Schwarz, Marcy and Constance Eichhorn. 1996. *Collaborative decision-making: use of multiattribute utility analysis to involve stakeholders in resolving controversial transportation issues*.

Shen, L. David, et al. December. 1998. *At-grade busway planning guide*. Center for Urban Transportation Research, Florida International University. www.cutr.eng.usf.edu/research/nuti/busway/Busway.htm

Sneller, Joe. September/October 1997. Buses that run on rails. *Mass Transit*: 50-55.

South Corridor Study, Transportation Alternatives. October 16, 2000. *Draft South Corridor evaluation summary*.

South/North Corridor Project. April 1999. *Supplemental draft Environmental Impact Statement*.

Transportation Research Board. National Academy Press. 1996. *TCRP Report 19, guidelines for the location and design of bus stops*. Washington, DC.

Tri-Met. 2000. *five-year intelligent transportation system plan*.

Tri-Met. Mar 2001. Unpublished ridership numbers for 2000 received from project client.

WestStart. February 8, 2001. *Bus-Rapid Transit and the American community, a national planning and design competition*.

About the Authors

MATTHEW PAHS (Matthew.Pahs@dot.state.mn.us) is a graduate of the Master of Urban and Regional Planning program at Portland State University. He is currently a planner for the Minnesota Department of Transportation.

MARK ROHDEN (markohden@myexcel.com) is a graduate of the Master of Urban and Regional Planning program at Portland State University. He is currently a planner for Tri-Met.

DAVID HAMPSTEN (David.Hampsten@pdxtrans.org) is a graduate of the Master of Urban and Regional Planning program at Portland State University, with specializations in land use, transportation, and urban design. He is currently a cartographer/GIS mapper for the City of Portland, Oregon Office of Transportation

SETH GALLANT (sethgallant@hotmail.com) is a graduate of the Master of Urban and Regional Planning program at Portland State University. He is currently working with a transit advocacy group on expanding Portland's MAX light rail system.

ROBERT BERTINI (bertini@pds.edu) obtained his Ph.D. in transportation engineering at the University of California at Berkeley. He is an assistant professor of civil and environmental engineering and a research associate in the Center for Urban Studies at Portland State University.

Ottawa and Brisbane: Comparing a Mature Busway System with Its State-of-the-Art Progeny

*Sean Rathwell and Stephen Schijns
McCormick Rankin Corp.*

Abstract

Brisbane, Australia's new South East Busway, which opened in 2000–2001, is one of the most technologically-advanced Bus Rapid Transit (BRT) systems in the world. It represents the “state-of-the-art” in busway design, infrastructure, and operations management.

The South East Busway and various other Brisbane busway initiatives are modeled on Ottawa, Canada's transitway system. Since commencement of operation in the early 1980s, Ottawa's network of bus-only roadways and stations has transformed the community into one of the most transit-friendly centers in North America.

Introduction

This article compares the BRT systems operating in Brisbane and Ottawa. Some elements are similar between the two while other elements are fundamentally different. The article also shows how BRT proponents created a successful system while addressing real-world issues faced in various situations.

The comparison directly incorporates components of BRT that are outlined in the recent TRB/TCRP publication “BRT—Why More Communities Are Choosing Bus Rapid Transit.” Thus, the reader can review the key elements of the successful Ottawa and Brisbane facilities in a systematic manner.

Setting

Ottawa, Canada's national capital, was founded in the 1820s on the south bank of the Ottawa River; Gatineau, Quebec, lies opposite the City. Ottawa spreads over flat, open terrain. Its 715,000 urban population has grown at a varying rate of between 1 percent and 2 percent per year over the past decade. The temperate climate sees daily average high temperatures of -6°C in January and 27°C in July. The full range is -37°C to $+38^{\circ}\text{C}$. Snow is a major factor, with an average of 220 cm falling between November and April.

Ottawa relies on buses. The City's once-extensive streetcar system was closed in 1959. In October 2001, a five-station Diesel Multiple Unit (DMU) Rail pilot project was opened. The transit mode share is 16 percent of all daily trips, amounting to 80 million trips per year.

Brisbane, the capital of Queensland, was founded in the 1820s along the serpentine Brisbane River. The City is 10 km inland from Moreton Bay on Australia's east coast. The terrain is a mixture of flats and rugged forested hills. Brisbane's current population of approximately 880,000 (region 1.6 million) has grown at a rate of 2 percent per year over the past decade. The climate is subtropical, with January daily high temperatures averaging 29°C and July averaging 20°C . The full annual range is 2°C to 43°C . Brisbane receives 120 cm of rain per year but has never experienced snow.

Brisbane has an extensive commuter rail network, splitting the transit market almost equally with the bus system at around 42 million trips per year. River ferries are also part of the transit mix. The City's once-extensive streetcar system was closed in 1969. There are several on-street bus lanes, high-occupancy vehicle (HOV) lanes, and priority measures in place. A freeway HOV lane was built adjacent to the South East Busway as part of the corridor works. Transit mode share is 7 percent of all daily trips.

Rationale and Concept Development

The region of Ottawa-Carleton was created through amalgamation in 1969 and set out to prepare an Official Plan (OP). The key OP statement was to "give precedence to public transit over all forms of road construction or road widenings" (Regional Municipality of Ottawa-Carleton 1974). The OP also linked land

use and transportation by placing most major employment centers next to rapid transit facilities. With provincial funding of 75 percent of transit infrastructure capital costs, the scene was set for developing a rapid transit strategy. The study of modes, costs, and service recommended transitways (grade separated) in five corridors. A detailed study of need, location, priority, staging, and technology followed in 1977–1981 (BBL-DeLeuw Cather-Dillon-IBI Group 1976). Diesel buses were selected over light rail transit (LRT) for reasons of cost and flexibility. BRT was seen as half as costly to build as LRT and 20 percent cheaper to operate, while providing a high proportion of transfer-free trips.

In the face of continued substantial growth in the 1980s and 1990s, Brisbane City Council and Queensland Transport collaborated on an Integrated Regional Transport Plan (IRTP) (Queensland Transport 1997) in the mid-1990s. Senior Brisbane staff and politicians had been impressed with the Ottawa approach to bus-based rapid transit and came up with a busway strategy for Brisbane (McCormick Rankin 1995), which was incorporated in the IRTP. Corridor studies followed as part of the IRTP process. In the southeast corridor, the government was quick to take advantage when a controversial proposal for a new highway to the Gold Coast was rejected in favor of widening the existing route. The State's commitment to upgrade the freeway through the urban area was met in the form of two bus lanes (i.e., busway). Under that rationale, the State government funded and built the South East Busway, while planning continues in the other corridors.

Route Planning

The Rapid Transit Appraisal Study identified five corridors radiating from central Ottawa (BBL-DeLeuw Cather-Dillon-IBI Group 1976). The corridor across the river to Quebec fell afoul of complicated planning, jurisdictional, and funding matters. In the other four, route selection reflected environmental, community, transit service, and cost factors (BBL-DeLeuw Cather-Dillon-IBI Group 1978–1981). Community and public input was substantial. The routes mainly used publicly owned land such as old streetcar rights-of-way, surplus freeway land, and parkway belts. They linked most of the major trip generators (employment, retail, service centers) in the region. An “outside in” strategy was used,

concentrating on construction in suburban corridors while operating on-street in bus lanes through the central business district (CBD), deferring the cost and impact of a CBD bus tunnel.

A Busway Strategy for Brisbane City (McCormick Rankin 1995) also identified five potential BRT corridors reflecting Brisbane's radial bus service pattern, but available rights-of-way were much more constrained than in Ottawa. With six radial rail routes already in place, the bus corridors avoided service area overlaps by locating between rail lines and providing intermodal transfer stations where technologies intersect. Within built-up corridors, a mix of grade-separated and on-street bus lane operations were contemplated in the concept plan, but most of the on-street segments in the South East corridor were replaced with tunnels during detail design, leading to a greater per-kilometer construction cost. The subsequent Inner Northern Busway makes more extensive use of existing roads.

Brisbane's preexisting underground CBD bus station provided a logical meeting point for the busway network. In time, the City intends to convert this terminal to an on-line station busway. Like Ottawa, getting the busways to the CBD was a higher priority than undertaking the costly link through the CBD itself.

Infrastructure Planning and Design

When Ottawa embarked on its busway initiative in the late 1970s, there were few reference materials or working examples available, and none featuring a northern climate. The Transitway Design Manual (Regional Municipality of Ottawa-Carleton 1993) was created from principles, covering all necessary structural, architectural, electrical, drainage, station layout, and geometric elements. Without operating experience, standards tended to be conservative with respect to such items as the need for shoulders and acceleration lanes. Where information was lacking, local field trials were arranged (e.g., bus acceleration out of stations, passenger reaction to platoon operation, station capacity under full operation). Considerable debate took place over station operations and platform length. Although bus had been selected over light rail to begin with, it was decided to project for LRT where it was cost-effective to do so. Thus, structural design,

Table 1
Overview of Ottawa and Brisbane BRT Systems

<i>Feature</i>	<i>Ottawa</i>	<i>Brisbane</i>
Citywide transit mode share	12% of all daily trips, 16% of peak period trips	7% of all daily trips, 13% of peak period trips
Citywide annual transit trips per capita	119	64
Citywide bus share of transit trips	99%	50%
Length	East, Southeast, West, Southwest, Central = 31.1 km – dedicated busway: 25.8 km – Bus on street: 5.3 km – Tunnel/viaduct: one 700m long tunnel	South East 16.3 km – dedicated busway: 16.1 km – Bus on street: 200m – Tunnel/viaduct: 8 tunnels of up to 510 m length/2
viaducts		
Stations	– Additional freeway/Arterial bus lane extensions: 35.3 km (25) – tied to development: 10 – stand-alone: 15 – intermodal integration: 3	– Additional freeway HOV lane extension: 20 km planned (10) – tied to development: 2 – stand-alone: 6 – intermodal integration: 2
Station characteristics	55 m x 6 m platforms, enclosed (heated) & open shelters, pedestrian bridge or underpass	55 m x 6 m platforms, open shelters, pedestrian bridge, real-time passenger information
Cross section at stations	4.0 m through lanes + 3.5 m stopping lanes + 1.5m median barrier	3.5 m through lanes + 3.0 m stopping lanes + 1.5 m median barrier
Cross section between stations	4 m lanes + 2.5 m shoulders	3.5 m lanes + 1.6 m shoulders
Park-and-ride lots/spaces	5/2660	1/370
Capital cost/cost per km	\$Cdn 398M/\$15.4M/km	\$AU 450M/\$27.6M/km (\$Cdn 360M/\$22M/km at current exchange rates)
Capital funding source	75% Province of Ontario; 25% Region of Ottawa-Carleton	100% State of Queensland
Construction period	1983–1996	1999–2001
Daily transitway ridership	442,600 boardings, 320,000 trips	58,000 trips
No. of bus routes	130	Parts of 60
No. of bus operators	1	6
Peak point, peak direction buses/ridership	200/10,000	150/9,000

clearances, and grades used LRT criteria. Perhaps the wisest decision was to treat the stations as significant, substantial “places” rather than as glorified bus stops; enclosed walkways and heated shelters meant that to transfer between buses in February no longer risked being a bitter, uncomfortable ordeal.

The Ottawa model of establishing as much as possible in a design manual before soil was turned was followed in Brisbane (McCormick Rankin International 1998). And, as experienced in Ottawa, the concept was new to Queensland and much had to be adapted from roadway experience. An architectural approach specific to Brisbane was developed, much more open than the winter-guided Ottawa style. Brisbane had longer and more numerous tunnels and more complex bus operations than Ottawa. Planners took advantage of latter-day advances in Intelligent Transportation Systems (ITS) technology to create a “wired busway” from the start. Colocation with light rail was a serious prospect in Brisbane at the time, with the Ottawa approach taken to protecting for LRT needs.

Running Ways—Standard

Ottawa’s basic transitway is nothing more than a two-lane roadway with paved shoulders. The travel lanes, at 4.0 m wide, are wider than typical general traffic lanes to provide an extra safety margin and reduce the air pressure disturbance between buses passing at 80 km/h. Vertical alignment, structural design, and clearance envelopes are governed by LRT constraints to protect for possible future conversion.

Paved shoulders were included as a refuge for disabled buses and for snow storage. Experience has shown, however, that if buses break down, they do so at stations so shoulders are rarely used for that purpose. The primary function of the shoulders is, therefore, for snow storage though they also do provide operational flexibility during road maintenance. In constrained areas, gutter drainage and mountable curbs are used. Shoulders are 2.5 m wide.

At stations, the road widens to four lanes to allow express buses to pass stopped ones at 50 km/h.

The design approach used in Ottawa was followed in Brisbane, with the obvious difference of not requiring shoulders for snow storage. The commitment

to full grade separation from crossing roads was maintained wherever physically possible. The lane width in Brisbane is 3.5 m, while shoulders are 1.6 m wide.

Learning from Ottawa's experience, bus deceleration and acceleration lanes at stations are trimmed to 20 m in length. It has turned out that the full length lanes provided in Ottawa (in the absence of operating experience, based on highway standards) were not used in real operating conditions; relatively low traffic volumes mean buses can reenter the through lane from a station with ease.

Running Ways—Exceptions

Key to transit's success and cost-effectiveness in Ottawa was the initial development of a region-wide BRT service that made selective use of existing roads, on-street bus lanes, and freeway bus ramp-stations. Although every year or two after 1983 new sections of busway were added, replacing temporary street and busway operations, the overall BRT service has remained essentially unchanged. Today, freeway shoulder bus lanes extend the transitway to suburban communities, while arterial bus lanes extend the system to the south. Eventually, these, too, will be replaced by busway. Through the downtown, on-street bus lanes link the East and West transitways. They operate in the second lane on a pair of one-way streets, leaving the curb lane for bus stops, couriers, right turns, and parking. A central tunnel was originally planned but was deferred to allow the rest of the transitway to be built first. This "outside in" strategy was the key to being able to afford an extensive transitway system in the first place. The success of on-street bus lanes means the costly tunnel is unlikely to ever be built.

The 25.8 km of transitway built between 1983 and 1996 cost \$Cdn 398M (approximately US \$250M at current exchange rates), or \$Cdn 15.5M per km, including 25 stations.

The extensive tunnel and viaduct segments of Brisbane's South East Busway maintain lane and shoulder width standards. The four-lane Victoria Bridge into the CBD was changed to carry the two-way busway alongside a two-way general-purpose roadway. At the busway's south end, buses transition to the Pacific Motorway, where they will eventually be able to take advantage of planned median HOV lanes to serve strategic stand-alone stations. The 16.3 km

of busway and 10 stations built in 1999 to 2001 had a total capital cost of approximately \$AU 450M (approximately US \$230M at current exchange rates), or \$AU 27.6 M per km.

Station Design

Transitway stations in Ottawa are substantial, distinct facilities, heavily influenced by the winter weather (Figure 1). A modular “kit of parts” was defined and applied across the system, for stronger “branding” and economy of scale. The bright red steel frames, curved glass, and concrete bases were far more substantial than bus passengers had been used to and signified that their comfort was being taken seriously for a change. Heated, enclosed on-platform waiting areas provide winter relief as well as central locations for passenger information. All stations are four lanes wide to allow express buses to pass stopped ones. Drainage is toward the median to eliminate the risk of waiting passengers being splashed. A barrier/fence in the median prevents pedestrians from crossing the transitway. Movement between platforms is by a bridge accessed by stair and elevator. Most platforms are 6 m wide x 55 m long.



Figure 1. Tunney's Pasture Station, West Transitway, Ottawa

The general approach to stations in Brisbane followed Ottawa's lead—a substantial, distinct, identifiable, functional, modular architecture—but design

focuses more on protection from subtropical sun and rain, with broad canopies over open platforms (Figure 2). The platforms are 6 m wide x 55 m long, using Ottawa's "lead stop" operational principle. Highly visible elevator towers linked by an enclosed pedestrian bridge mark most stations. The tropical green and horizontal elements help the stations blend in to their surroundings much more than in Ottawa. Each station precinct was subject to an urban design effort.

Like Ottawa, park-and-ride facilities were consciously limited to the outermost station. This represents a significant break from Brisbane's traditional reliance on park-and-ride provisions at rapid transit (i.e., rail) stations.



Figure 2. Griffith University Station, South Busway, Brisbane

Station Integration

Of Ottawa's 28 transitway stations, more than one quarter are physically integrated with adjacent development. The most significant example is at St. Laurent Shopping Centre, where the owners donated the land (in return for relief on parking requirements) and a bilevel station, linked directly to the mall, was created (Figure 3). Some 30 percent of St. Laurent patrons now come by bus. This formula was repeated at Blair, Orleans, Billings Bridge, and South Keys. At Riverside Hospital, an expansion reached out atop the new station (Figure 4). Most other stations are stand-alone with links to nearby attractions.



Figure 3. St. Laurent Station, East Transitway (lower left) linked with Regional Mall (surface level shown; transitway operates in tunnel below)



Figure 4. Riverside Hospital extends over a transitway station

The South East Busway has 10 stations. Like Ottawa, one station is integrated into a regional shopping center (Garden City) and the other is within a hospital complex (Mater Hill). In both cases, busway construction was tied into concurrent site redevelopment work. Although a complex legal and working environment ensued, the resulting coordinated facilities benefit both parties. At Mater Hospital, new operating theaters are suspended above the busway station (Figure 5).

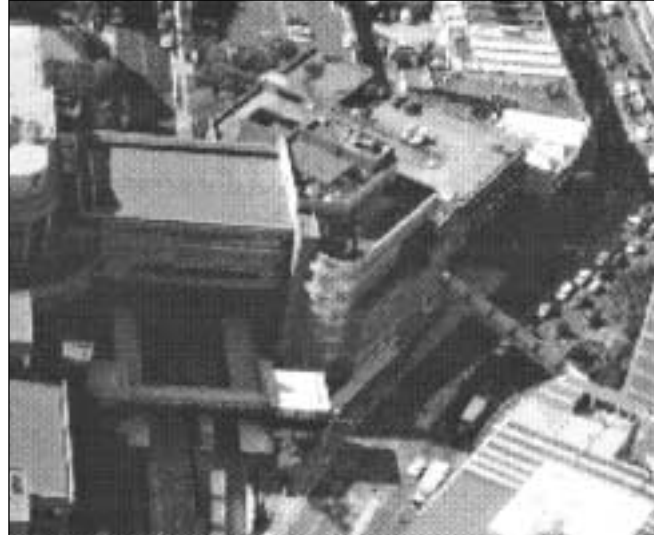

Figure 5. Mater Hospital straddles the busway and station

Two other stations provide direct links to adjacent commuter rail stations and have created significant new transfer opportunities.

The Cultural Centre station was the product of intense negotiations between the proponent and the stakeholders in an architecturally-controlled arts precinct. It was designed to provide for dual LRT and bus functions, but with the demise of the LRT proposal it is to be rebuilt to function better as a purely bus-oriented facility.

Vehicles

Ottawa does not apply special vehicles to the transitway. Standard 40-foot and articulated 60-foot diesel buses are used across the OC Transpo fleet and any route can be assigned any bus. The all-stops trunk transitway services are normally provided by articulated buses. Selected transitway buses carry bicycle racks. OC Transpo has investigated the use of natural gas but determined that the costs of mid-day fueling and retrofitting indoor storage (a requirement given the winter conditions) for the 800-plus fleet are prohibitive. OC Transpo is acquiring improved diesel technology as new buses are purchased and is observing fuel cell tests with interest. Use of the underground station at St. Laurent by diesel

buses has not been an issue. The station features open platforms and its ventilation system was designed for such uses.

Brisbane's South East Busway is used by several operators, although the vast majority (approximately 80%) of the buses are part of the City-owned Brisbane Transport (BT) fleet. BT, like OC Transpo, has a fleet of standard and articulated diesel-powered vehicles, although there are only 22 artic in use at present. Many of the other operators serve long-distance (20–30 km) suburban areas and use single-door highway coaches. Most buses use the underground Queen Street bus station in central Brisbane. Platforms there are enclosed to prevent migration of emissions to the adjoining retail areas.

All bus operators undergo a training course before being authorized to use the busway.

Route Structure

Four types of service operate on Ottawa's transitway system: mainline, crosstown, local, and peak period. Articulated buses stopping at all stations provide main line service at a frequency of 3 to 5 minutes in the peak and 5 to 8 minutes at other times. Some crosstown routes simply use the transitway to connect two areas of the City, while local routes feed stations and connect neighborhoods. Peak-period expresses are the highlight of Ottawa's BRT system, circulating within suburbs then running express via the transitway with time and reliability results the automobile can not beat. Some reverse expresses serve outlying centers in peaks periods. Almost all of Ottawa's 130 bus routes use or touch a segment of the transitway. Combined services result in one bus per minute in outlying areas and more than 200 buses per hour per direction in the CBD.

Brisbane's established pattern of suburb-to-CBD express services was supplemented by new busway trunk (all-stop) runs to accommodate transit demand. Trunk service now operates at 2.5-minute headways in the peaks. The frequent trunk busway service will allow development of new neighborhood feeder services. Unlike Ottawa, Brisbane's busway accommodates several different operators. Suburban contractors stop at one or two outlying stations then run express to the CBD, while BT picks up everything in between. Express passengers can transfer to the frequent all-stops services to gain access to intermediate stations.

New service agreements reflect the impact of the busway on suburban operators, allowing operators to pick up passengers within each others' areas. The South East Busway hosts parts of some 60 bus routes, with 150 buses per hour per direction during peak periods.

Fare Collection

Ottawa chose to continue using the conventional on-bus fare collection technology and fare media applied to the rest of the system. This allowed stations to be unstaffed; there are no fare-paid areas on platforms. The associated risk of lengthy boarding times was mitigated by the promotion and high uptake of monthly passes (some 70% of OC Transpo trips use monthly passes; higher during peak commute times) and by allowing rear-door boarding of articulated buses by pass users and passengers with proof of payment (a transfer from another bus). A random inspection program minimizes fraud. Cash fares are significantly higher than pass users, and express buses command a premium fare. OC Transpo plans to move to a Smart Card fare system in the future.

The fare system in Brisbane is considerably different from Ottawa's. BT features a zone-based fare system and bus drivers make change on the vehicle. The system does not offer monthly passes. Given these conditions, along with single-door entry and relatively few articulated buses in use, the risk of delays at stations with heavy boarding volumes is a major planning concern. The situation has been manageable to date. For special events, on-platform ticket agents are used to speed boarding, and the substantial use of one-seat express trips has reduced transfers at stations. However, the busway project has been a catalyst for Queensland Transport to introduce a Smart Card program, which will improve station operations and allow improved coordination between bus operators and between bus and train services. The Smart Card program was not in place for busway opening but is anticipated in the next year or two.

Intelligent Transportation Systems (ITS)

Ottawa's transitway system predates much of what is currently known as ITS, although OC Transpo has always been in the forefront of automated vehicle location and control (AVLC), passenger information (automated next bus

information by phone), and automatic passenger counting. AVLIC “electronic signposts” provide bus location information to service control center operators, who look after the entire system and can consider the network implications of any service interventions. Stations have push-button help phones, and cameras are gradually being introduced to ensure customer security. The transitway is not treated separately from the rest of the OC Transpo system.

The Queensland government made ITS an integral part of the busway project from the start. Bus operational management, plant (tunnel systems, elevators, pumps, etc.) monitoring and control, passenger security, and passenger information were all addressed with state-of-the-art technologies applied in each area. Brisbane City Council’s RAPID bus monitoring system (tracking tagged buses via in-road detector loops) was extended to the South East Busway and used as a basis for real-time dynamic “next bus” information provided to passengers at stations. Since neither the Brisbane traffic control center, the highway traffic operations center, nor the BT radio room were physically or operationally capable of taking on the new busway task, all systems were brought together at a purpose-built busway operations center (BOC). Rather than have each operator run its own buses on the facility, the need for coordination and safety means that bus management is “handed off” to the BOC from the operators’ own dispatchers upon approaching the busway. ITS features help protect the State’s infrastructure investment while meeting traveler expectations and attracting new transit users.

Organizational Structure

The Region of Ottawa-Carleton (now City of Ottawa) built the transitway, with 75 percent of the capital cost provided by the Province of Ontario. The City is also responsible for OC Transpo, the monopoly transit service in Ottawa. OC Transpo adapted its organizational functions to reflect its responsibility for operating the new facility. Plant Maintenance took on the maintenance task, Operations shifted to focus on major transitway stations, new passenger security activities were implemented, and Public Information adapted to the new system.

The State of Queensland built the South East Busway for use by area bus

operators. The State contracts out bus operations on a geographic basis and is not itself a service provider. One of the greatest challenges, therefore, in operating Brisbane's first busway was to define an appropriate organizational structure. Queensland, having funded its construction, could not simply hand the \$500M facility to Brisbane City, nor did the City want to take on the maintenance and operating cost of the facility. The State's Public Transport division mainly managed contracts and had little tradition of owning or operating major infrastructure, while local bus operators had neither the interest in taking it on nor the resources to do so. Although the busway lies entirely within the BT service area and it is the major user, other suburban operators that use it to serve the vital CBD market did not wish to yield control of their operations on the busway to BT. Consideration was given to privatizing the facility and/or its operation.

The solution was to operate the facility initially under State direction, while working toward a permanent administrative structure that may or may not involve the City, bus operators, and/or the private sector.

Performance and Ridership

OC Transpo's ridership peaked at 85 million annual riders in 1985, shortly after the first sections of the transitway opened. Subsequent large-scale changes (growth in suburban office parks, downsizing by the City's major employer [federal government], and a sociodemographic swing away from the prime transit market) saw ridership drop to 70 million by 1998. During this period, transitway use remained stable. Increased population, economic growth, and service restructuring have since seen ridership rebound to almost 85 million per year. Weekday systemwide boardings are currently 442,600, of which 200,000 are on the 68 bus routes assigned to trunk transitway services. The peak-period peak-point load on the transitway exceeds 10,000 passengers per direction.

BT carries approximately 42 million trips per year and recent years have shown a moderate growth trend. In the first week of operation on the South East Busway, BT reported an increase of 25.7 percent in patronage on core busway services. The increase was 40 percent after six months and has continued to grow, albeit at a more moderate pace. Some 58,000 trips per day are currently being taken on the busway. The one park-and-ride lot is full.

The impact on ridership of improved bus travel time and reliability compared to operating in congested freeway and street traffic was difficult to model because of the lack of comparable local experience. Consequently, demand modeling underestimated patronage take-up. The 10-minute frequency of the all-stops spine service was quickly reduced to 2.5 minutes in peaks and 5 minutes off-peak—above the year 2011 targets. The main problem in the first year of use was overloading and lack of buses to keep up with demand. The A.M. inbound peak-hour, peak-point volume on the South East Busway is 150 buses carrying 9,000 passengers.

Impact

The transitway has been one of the key components of making public transit an important part of everyday life in Ottawa. The integration of stations with adjacent land use and the provision of innovative services to take advantage of the facility has meant that:

- more than 50 percent of all people entering downtown do so by bus;
- the suburban St. Laurent Shopping Centre features a remarkable 30 percent transit mode share for shoppers;
- 3,200 residential units and 440,000 m² of institutional and commercial space was built near transitway stations in the eight years prior to 1996; and
- bus is the fastest mode available between the airport and downtown.

Brisbane's South East Busway was an immediate success in terms of operations and ridership. The first week of full operation saw BT record a 26 percent increase in core busway service use; after six months, the increase had reached 40 percent. Gains continued until all available buses were operating with standees; further promotion has been held in abeyance pending acquisition of additional buses. Passengers are changing long-held travel patterns to use the new transfer and stopping opportunities. The system carries up to 60 percent of the crowd to sports events at Woolloongabba Stadium, Brisbane's major venue, up from 10 percent prebusway.

Busway extensions and further service improvements yet to come will continue to draw new travelers to this mode. The impact of the busway on its surroundings has yet to be strongly felt, apart from those stations that were integrated into existing development. Nevertheless, some sites do have (re)development potential. An analysis of property values eight months after the busway opened showed that values in residential neighborhoods served by the South East Busway had grown at a rate up to two to three times faster than in nonbusway suburbs.

Challenges

Ottawa's transitway benefited from provincial funding; without the 75 percent contribution to capital cost from Ontario it never would have been built. The elimination of that support in the late 1990s, and the recent reinstatement of partial support, has posed problems for the completion of planned extensions. In the meantime, despite Ottawa being one of the touchstones of bus-based rapid transit and the busway being highly rated by its users, political interest has swung toward LRT. An 8 km-long diesel LRT pilot project opened in 2001, utilizing a little-used freight line to link two transitway stations with three intermediate stops; its current daily ridership is about 4,500. Future LRT initiatives may be more challenging, however. The on-street bus operation through downtown would undeniably be better via a tunnel, but the incremental benefit may not be worth the price. Despite the strength of Ottawa's commitment to transit planning principles, the inability to control the location of development has meant that much recent growth has occurred in suburban areas far from the transitway or in sprawling non-transit-oriented "power centers."

Queensland's first busway is being carefully assessed to determine if it is a one-off product of a unique combination of political, financial, and functional circumstances or is a valid prototype for the rest of the proposed five-line network. Construction is underway on the 5 km-long Inner Northern Busway, albeit on less generous financial terms. Other corridors may evolve through on-street bus priority measures instead. In any case, the State will have its hands full for years to come in sorting out an appropriate administrative structure; introducing regional Smart Card/fare integration measures; resolving the capacity and operational problems posed by the Cultural Centre, Queen Street bus terminal, and

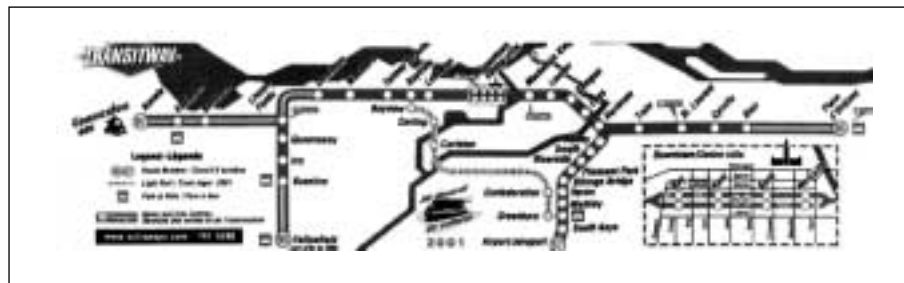

Figure 6. Ottawa transitway system

CBD street use; capitalizing on development opportunities around stations; and updating operator agreements.

Conclusions

Ottawa's transitway system was a success from the start and in its mature state provides the City with some of the best bus-based rapid transit in North America. Key has been the organizational structure that allowed a single public entity to plan, design, construct, operate, and maintain both the transitway system and all the vehicles on it. The transitway facilities and services are treated as integral, but not special, parts of the OC Transpo system (Figure 6).

Ongoing political commitment to an Official Plan that emphasizes transit before private automobile as well as the important land-use/transportation interaction has been evident in Ottawa since the early 1970s. This has allowed transit, in general, and rapid transit, in particular, to achieve a universal awareness in the community.

The transitway system incorporates on-street operation, freeway and arterial bus lanes, and signal priority to supplement the bus-only roadway backbone. This highlights the fact that the user's interaction with an effective BRT system is at stations; what lies between is only important insofar as it moves passengers between stations. The focus on stations—location, scale, amenity, and function—that is the hallmark of the transitway system has served it well.

Queensland had the opportunity to observe the world's best practice and learn from it. Within a very short period of time, Brisbane went from a place where the busway concept was unknown to operating a tremendously successful

\$AU 450M facility. The level of funding and commitment to quality for the South East Busway may prove to be unsustainable, but it has set a high standard.

Over and above the busway's impact on individual travelers in the Brisbane area, its role as a catalyst for organizational and functional change cannot be understated. Unlike Ottawa, responsibility for public transport is split between State and City, a situation that in the past had proven difficult to overcome. The South East Transit Project broke the logjam.

In bus operations, infrastructure design, intermodal coordination, ITS, passenger service, and urban design, the busway moved far beyond established practice in South East Queensland and forced all those involved to raise standards, take new approaches, and work together in ways they never had before. The legacy will profoundly affect public transport in the State, while the busway and its future extensions will evolve into established elements of the region's transport system.

With only a year of full operation complete, it is too early to fully assess the impact of the South East Busway on the urban form and travel patterns of southern Brisbane. As the Inner Northern Busway comes on line and other corridors are developed for BRT, the impact of the transportation decisions made by Queensland in the 1990s will be felt for decades to come. Initial success in terms of operational functionality, public acceptance, and ridership bodes well for the BRT future in Brisbane. At the very least, Brisbane has demonstrated the transferability of the busway/BRT concept between different settings—and hemispheres.

References

- BBL-DeLeuw Cather-Dillon-IBI Group. 1976. *Rapid transit appraisal study*. Ottawa.
- BBL-DeLeuw Cather-Dillon-IBI Group. 1978–1981. *Ottawa-Carleton rapid transit development programme*, 1–8. Ottawa.
- McCormick Rankin. 1995. *A busway strategy for Brisbane City*. Brisbane: Brisbane City Council.
- McCormick Rankin International. 1998. *Metropolitan Brisbane busway program—Busway planning and design manual*. Brisbane: Brisbane City Council/Queensland Transport.

Queensland Transport. 1997. *Integrated regional transport plan for South East Queensland*. Brisbane: Queensland Government.

Regional Municipality of Ottawa-Carleton. 1974. *Official plan*. Ottawa: RMOC.

Regional Municipality of Ottawa-Carleton. 1993. *Transitway design manual*. Ottawa: Transportation Department, RMOC.

About the Authors

SEAN RATHWELL (srathwell@mrc.ca) was involved in the planning, design, construction, and operation of Ottawa's transitway for 15 years. Mr. Rathwell holds bachelor and master of engineering degrees from Carleton University in Ottawa, Canada. He is a former manager of service planning at the Ottawa-Carleton Regional Transit Commission, and is currently a project manager with McCormick Rankin.

STEPHEN SCHIJNS (sschijns@mrc.ca.) has been directly involved in three of the milestone busway projects of the past two decades—Ottawa, Pittsburgh, and Brisbane. Mr. Schijns began his career as a designer on the Ottawa system and was stationed in Brisbane's South East Transit Project Office from 1999 until 2001. Mr. Schijns holds a bachelor of science degree from Queen's University, Kingston, Canada. He is a project manager with McCormick Rankin, where he has worked since 1983.